



# Ersatzteilliste für HIMOTO Burstout Motocross Motorrad RTR Maßstab 1:4

**MX400 Burstout Motorrad**

**Bestell-Nr.**

**650022**

**MX400 Burstout Motorrad Brushless**

**650024**

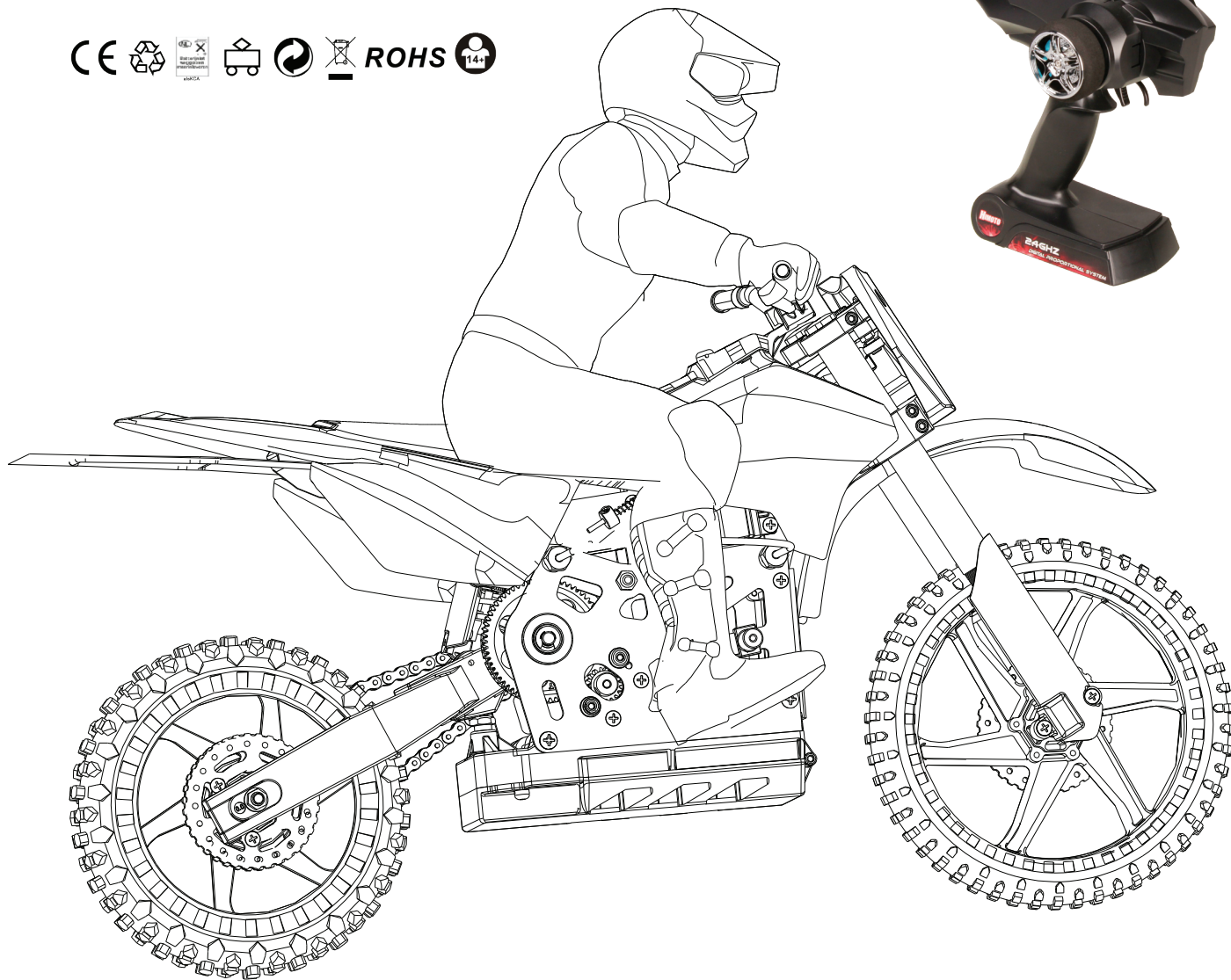

Modell	Länge	Breite	Höhe	Radstand	Untersetzung	Gewicht	Motor	Fahrtregler	Akku
MX400	519 mm	178 mm	291 mm	356 mm	12,3:1	3,25 kg	RC550	Vorw./Bremse Autosetup	7,2V NiMH
MX400BL	519 mm	178 mm	291 mm	356 mm	14,6:1	3,25 kg	3650 BL	Programmierbar 60A	7,4V LiPo

## Wichtige Hinweise:

Dieses Produkt ist kein Spielzeug, es ist nicht für Kinder unter 14 Jahren geeignet. Das Modell ist nur für den Betrieb außerhalb geschlossener Räume vorgesehen. Beachten Sie alle Hinweise dieser Bedienungsanleitung. Diese enthält wichtige Informationen über den Umgang mit dem Fahrzeug.

Bei Schäden, die durch Nichtbeachtung dieser Bedienungsanleitung verursacht werden, erlischt die Gewährleistung/Garantie. Für Folgeschäden übernehmen wir keine Haftung! Bei Sach- oder Personenschäden, die durch unsachgemäße Handhabung oder Nichtbeachten der Sicherheitshinweise verursacht werden, übernehmen wir keine Haftung! Von der Gewährleistung und Garantie ausgeschlossen ist ferner normaler Verschleiß beim Betrieb und Unfallschäden.

## Ersatzteilbeschaffung

Sollten Ersatzteile für das Modell benötigt werden, ist der Fachhändler vor Ort gerne bei der Beschaffung behilflich. Sie erhalten die verfügbaren Ersatzteile auch über unseren Internetshop **[www.krickshop.de](http://www.krickshop.de)**.

Die nachfolgenden Seiten mit Abbildungen helfen bei der Identifizierung von benötigten Ersatzteilen. Außerdem sind Detailzeichnungen und Gesamt-Explosionszeichnungen mit Ersatzteil-Nummern vorhanden.

In der englischen Original-Bauanleitung von HIMOTO werden bei den Ersatzteilen die HIMOTO Teile Nummern angegeben. Um bei Bestellungen von Ersatzteilen Verwechslungen zu vermeiden, bitte nur die Krick Bestell-Nummer verwenden. Änderungen und Irrtümer vorbehalten.

Hilfe bei Problemen

## Sinnvolle Ergänzungen zum HIMOTO Burst MX400

**79513** Für alle Akkutypen verwendbar



Himoto E6650 Schnell-Ladegerät 12V/230V. Für Akku mit GH4 Stecker zusätzlich 79502 bestellen.

**79502** Nur für Akkus mit GH4 Stecker verwendbar

Ohne  
Abbildung

Ladekabel GH 4 mm  
30 cm

**956080** Nur für die Brushless-Version verwendbar



Stecker GH 4 mm lose zum umrüsten von Steckverbindungen / Akkus

**956811** Nur für LiPo-Akkus verwendbar



RFI Unterspannungsalarm für 2-4 LiPo/Li-Ion Akkus

**667219** Nur für die Standard-Version verwendbar



HIMOTO Racingpack 7,2V 3000 mA Tam.-Stecker. 50% längere Fahrzeit als mit dem serienm. Akku.

**667224** Nur für die Brushless-Version verwendbar



HIMOTO Hardcase LiPo 7,4V 2700mA GH4. Ohne Umbaumaßnahmen verwendbar.

**957143** Nur für die Standard-Version verwendbar



RFI Hardcase LiPo 7,4V 3200 mA Tam. Stecker. Benötigt LiPo Lader 79513 oder 79512

**957142** Nur für die Brushless-Version verwendbar



RFI Hardcase LiPo 7,4V 3200 mA T-Plug 20C. Steckerverbindung muss auf GH4 umgelötet werden. Benötigt 956080

**952190** Nur für die Brushless-Version verwendbar

Ohne  
Abbildung

RFI Hardcase LiPo 7,4V 4000 mA T-Plug 25C. Gutes Preis/Leistungsverhältnis. Steckerverbindung muss auf GH4 umgelötet werden. Benötigt 956080

**952510** Nur für die Brushless-Version verwendbar



RFI Hardcase LiPo 7,4V 5000 mA T-Plug 30C. Hochleistungsakku Steckerverbindung muss auf GH4 umgelötet werden. Benötigt 956080

**957352** Nur für die Brushless-Version verwendbar

Ohne  
Abbildung

RFI Hardcase LiPo 7,4V 6000 mA T-Plug 50C. Wettbewerbsakku. Steckerverbindung muss auf GH4 umgelötet werden. Benötigt 956080

**957347** Nur für die Brushless-Version verwendbar

Ohne  
Abbildung

RFI Hardcase LiPo 7,4V 6500 mA T-Plug 20C. Maximale Fahrzeit!! Steckerverbindung muss auf GH4 umgelötet werden. Benötigt 956080

## Stoßdämpferöl Silicon 50 ml verschiedene Viskositäten

**682005**



**682010**



**682015**



**682020**



**682025**



**682030**



**682040**



**682050**



Je größer die Zahl der Viskosität (CPS) je zäher das Öl je höher die Dämpfungswirkung der Stoßdämpfer





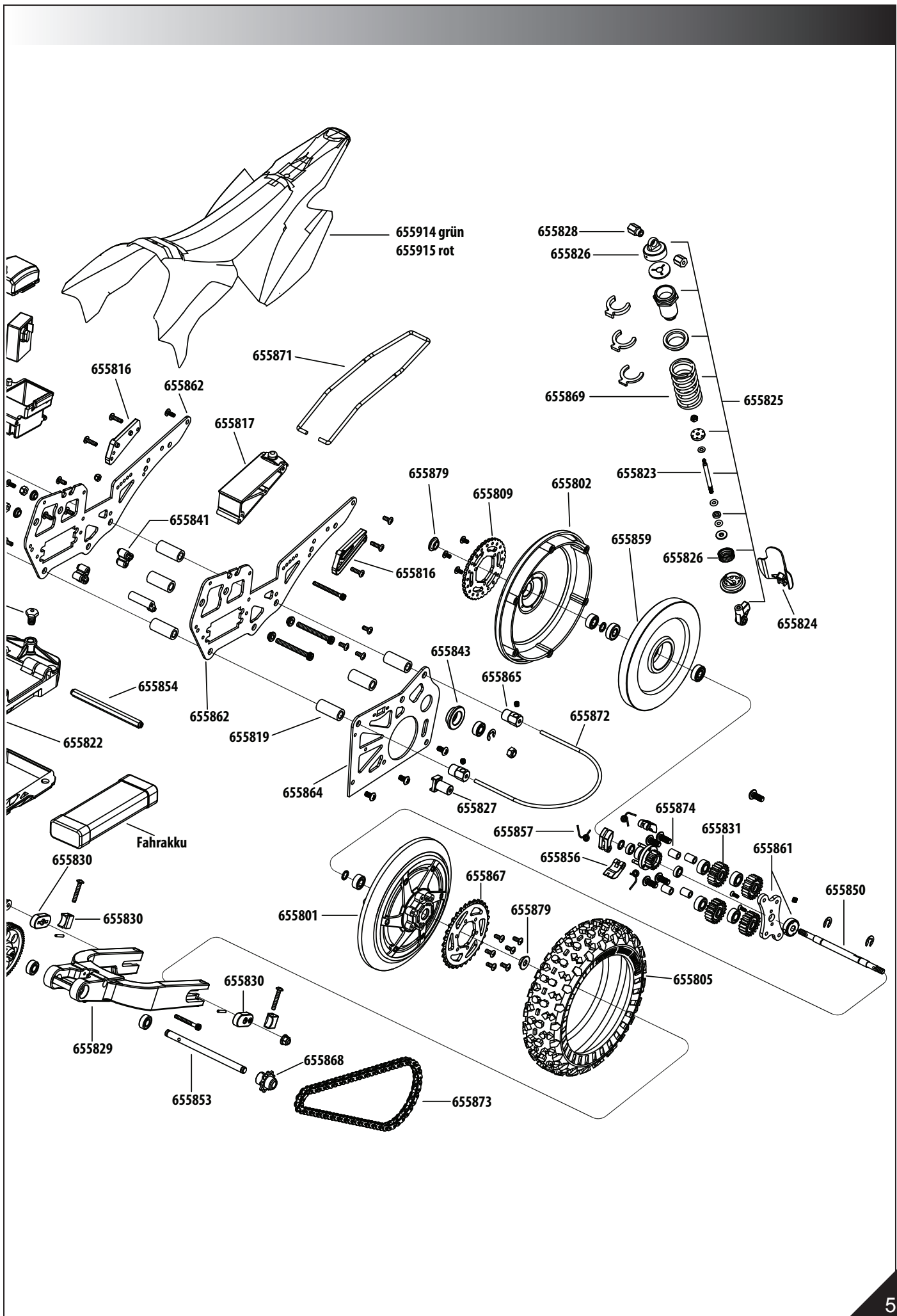



× 9  
**616152**  
 Flachkopfschraube  
 M3x8

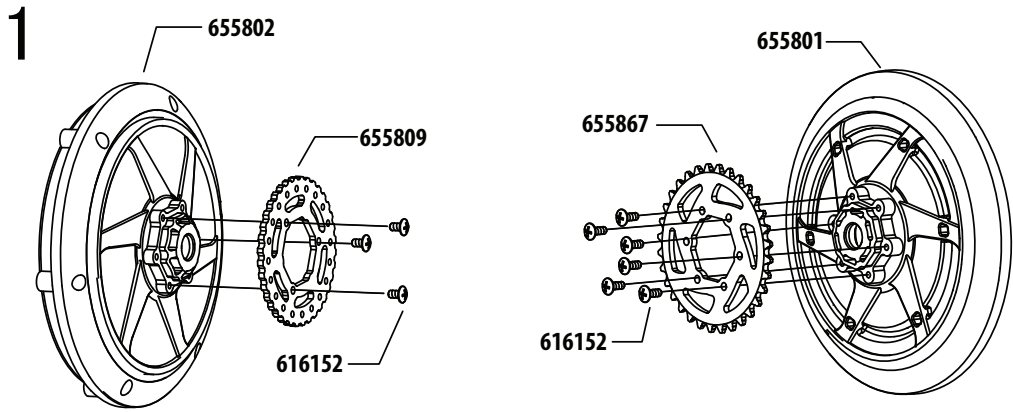

× 1  
**616271**  
 Madenschraube  
 M5x5



× 2  
**616301**  
 Flachkopfschraube  
 M4x12



× 2  
**667761**  
 Kugellager 6x10x5



× 2  
**655879**  
 E-Clip 5,0



**616104**  
 Senkkopf-Schraube  
 M3x5



× 4  
**667763**  
 Kugellager 6x13x5



× 2  
**667765**  
 Kugellager 6x15x5

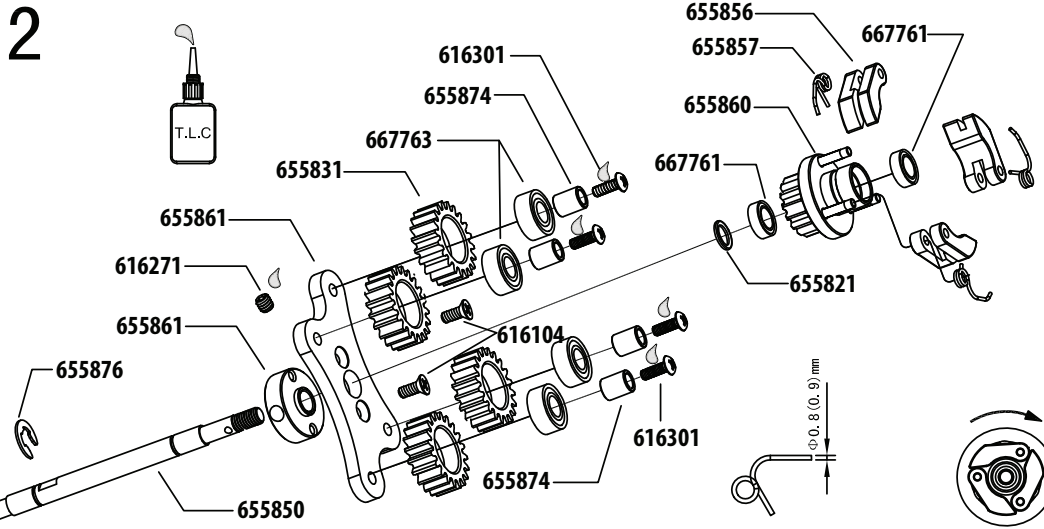

Achtung: Richtige Kupplungsfeder wählen  
 Standard Motor - 0,8 mm Ø  
 Brushless Motor - 0,9 mm Ø

Achtung:  
 Drehrichtung beachten

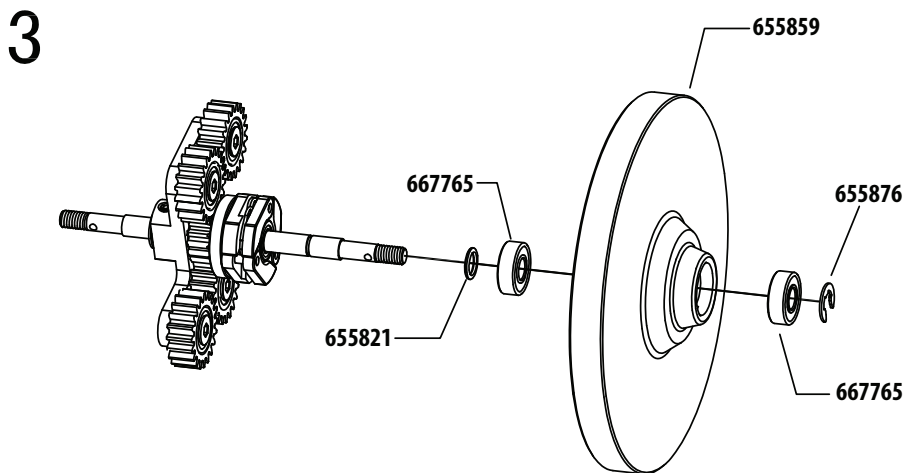

# 4



× 2

**667763**  
Kugellager 6x13x5



× 6

**616213**  
Innensechskantschraube M4x16

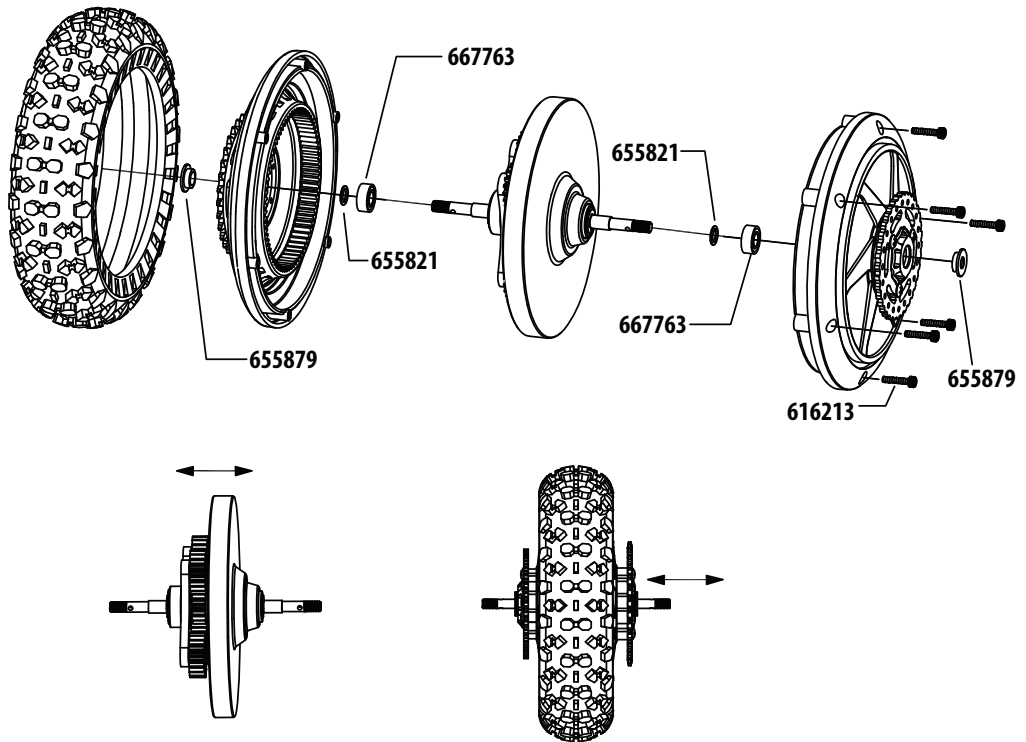

Wichtig: Zwischen der Gyroachse und dem Gehäuse ist nur minimal Axialspiel erlaubt. Um das Spiel der Achse zu justieren werden Schimscheiben Bestell-Mr. 655922 eingesetzt oder entfernt.



× 3

**616152**  
Flachkopfschraube M3x8

# 5



× 2



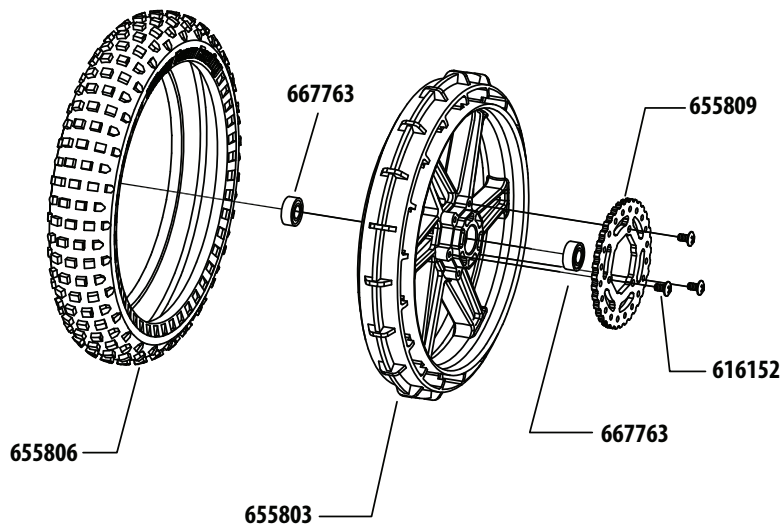

**667763**  
Kugellager 6x13x5

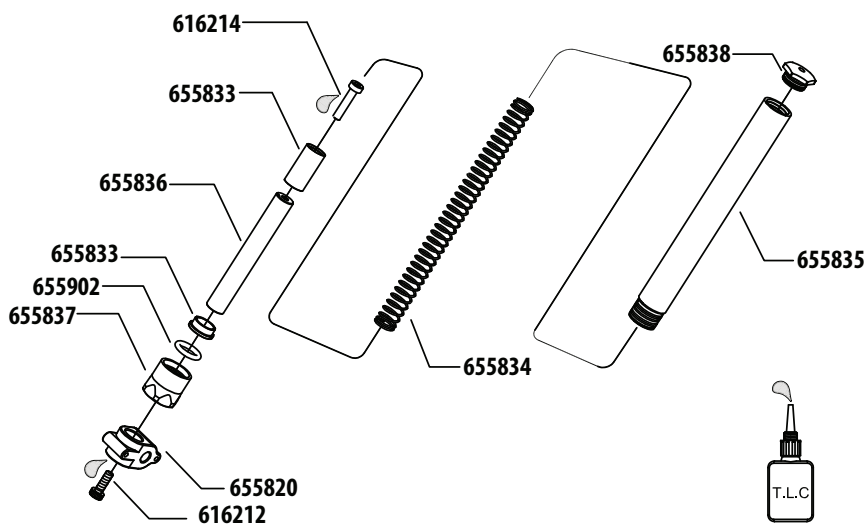

-  × 2  
616212  
Innensechskant-  
schraube M4x10
-  × 2  
616214  
Innensechskant-  
schraube M4x20

6



-  × 2  
616212  
Innensechskant-  
schraube M4x10
-  × 10  
616152  
Flachkopf-  
schraube M3x8
-  × 6  
616222  
Innensechskant-  
schraube M3x12
-  × 2  
616403  
Stopfmutter M4  
mit Flansch

7

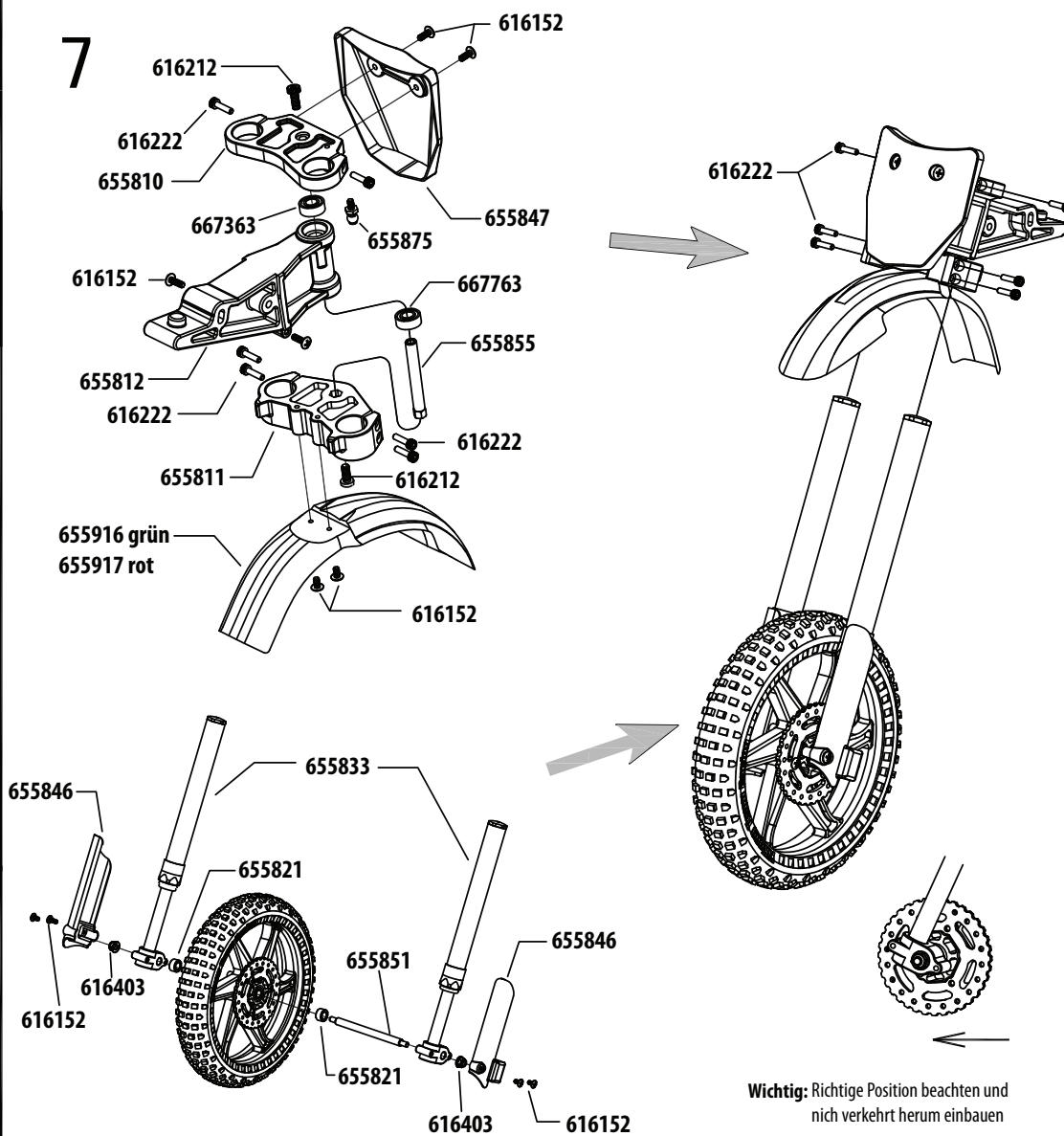



× 5

**616152**  
Flachkopf-  
schraube M3x8



× 4

**616313**  
Flachkopf-  
schraube M3x16



× 12

**616152**  
Flachkopf-  
schraube M3x8



× 4

**616303**  
Flachkopf-  
schraube M4x8

**8**

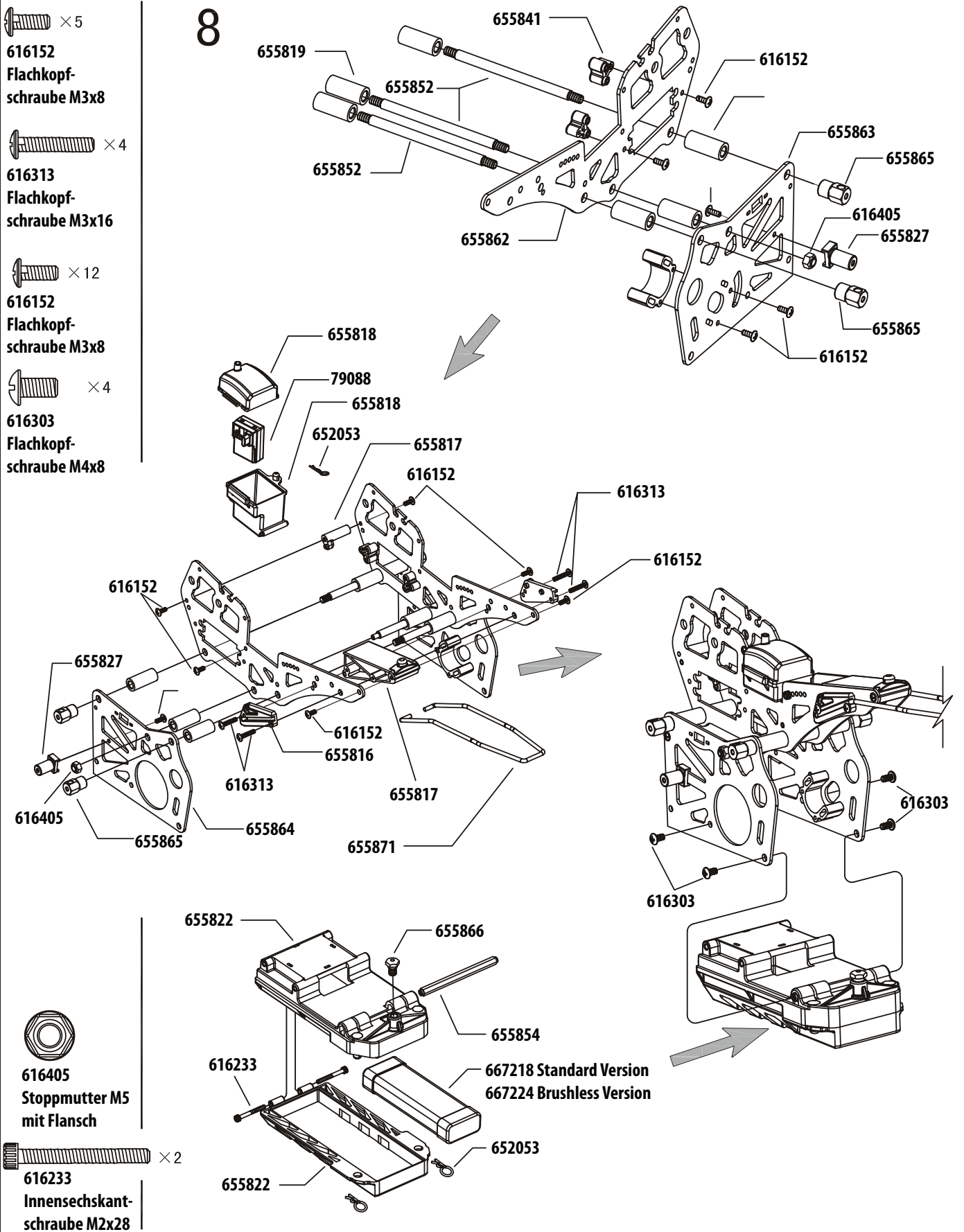

**616405**  
Stopfmutter M5  
mit Flansch



× 2

**616233**  
Innensechskant-  
schraube M2x28



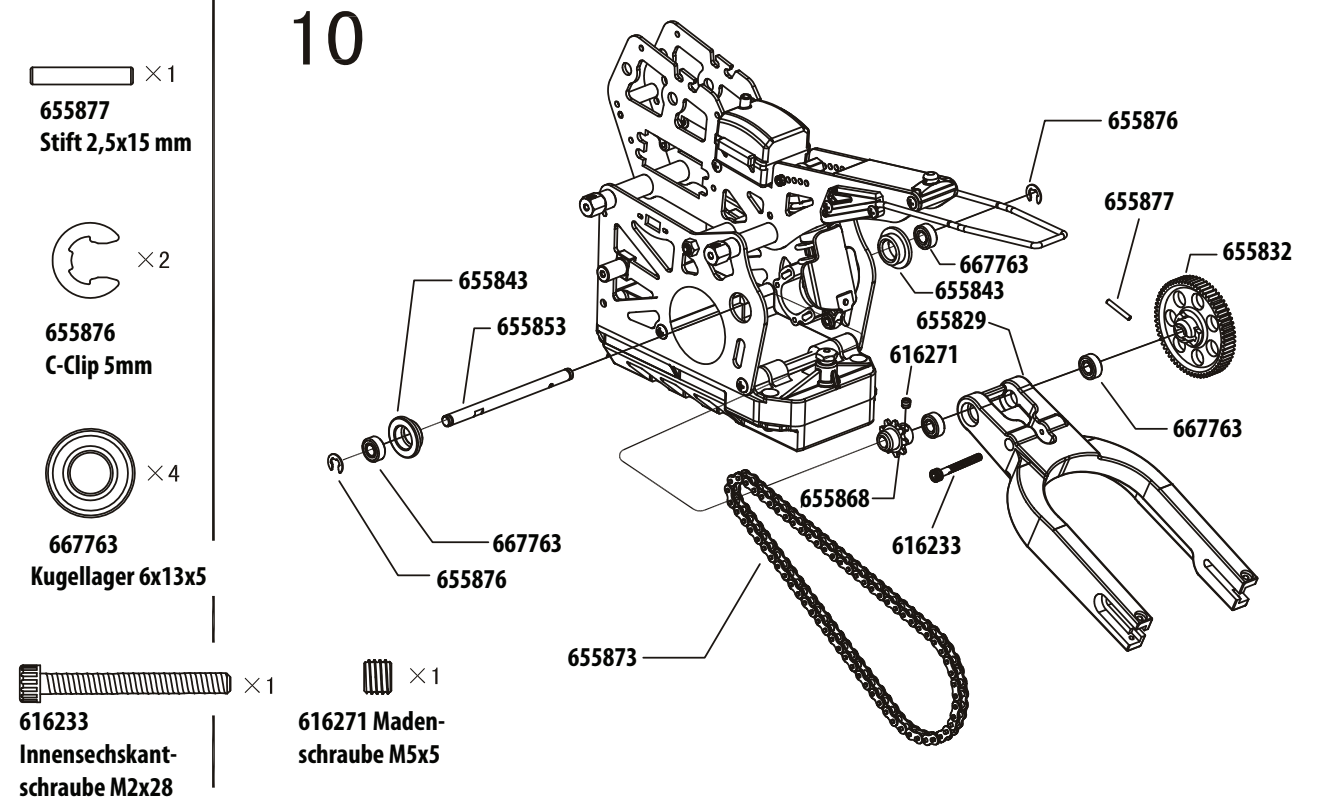
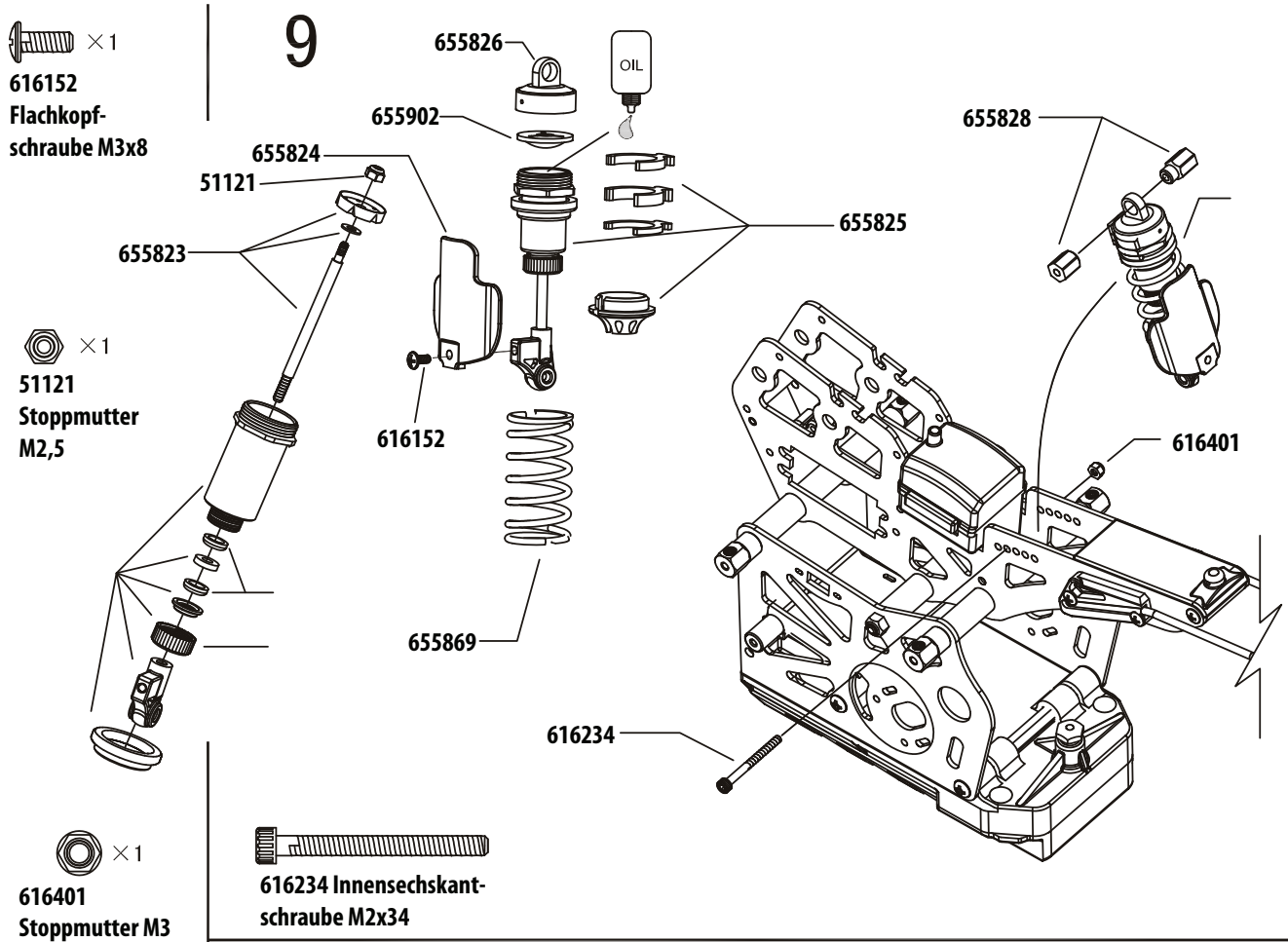



# 11



× 5  
616152  
Flachkopf-  
schraube M3x8



× 2  
616403  
Stoppmutter M4  
mit Flansch



× 2  
616217  
Innensechskant-  
schraube M4x38

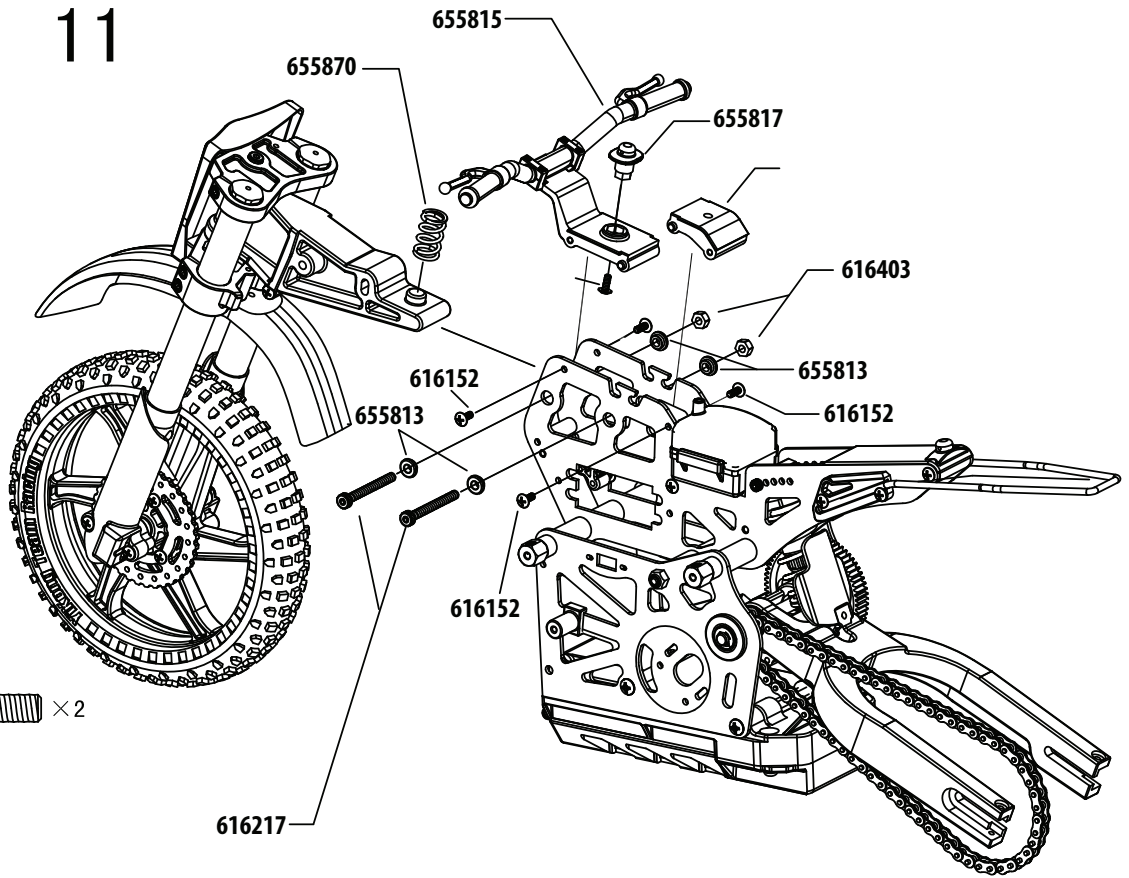

# 12



× 4  
616271  
Madenschraube  
M5x5



× 2  
616155  
Flachkopf-  
schraube M3x20

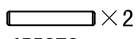

× 2  
655878  
Stift 2x13 mm

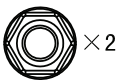

× 2  
616405  
Stoppmutter M5  
mit Flansch

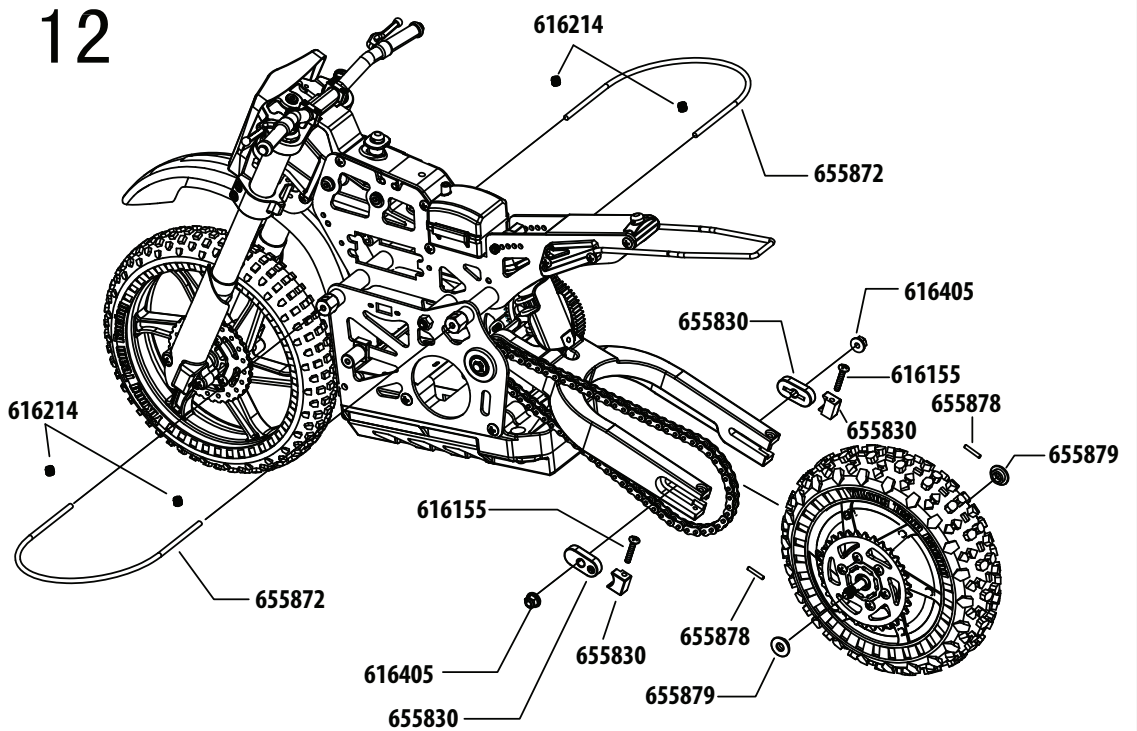

# 13

 × 4  
**616153**  
 Flachkopf-  
 schraube M3x10

**Motor**  
 42137 Standard  
 42402 Brushless

 × 1  
**616151**  
 Flachkopf-  
 schraube M3x12

 × 3  
**616261**  
 Madenschraube  
 M4x4

 × 2  
**616232**  
 Innensechskant-  
 schraube M3x22

 × 3  
**616152**  
 Flachkopf-  
 schraube M3x8

 × 2  
**616301**  
 Flachkopf-  
 schraube M4x12

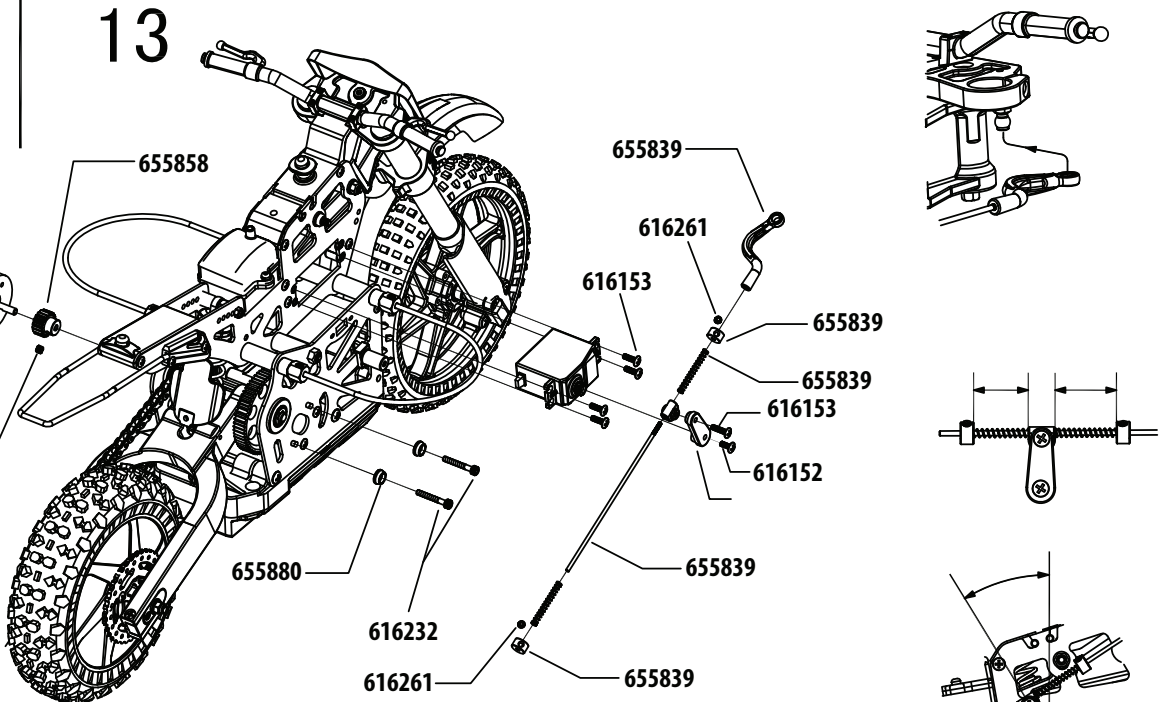

# 14

655914 grün  
 655915 rot

652053

616301

616152

616152









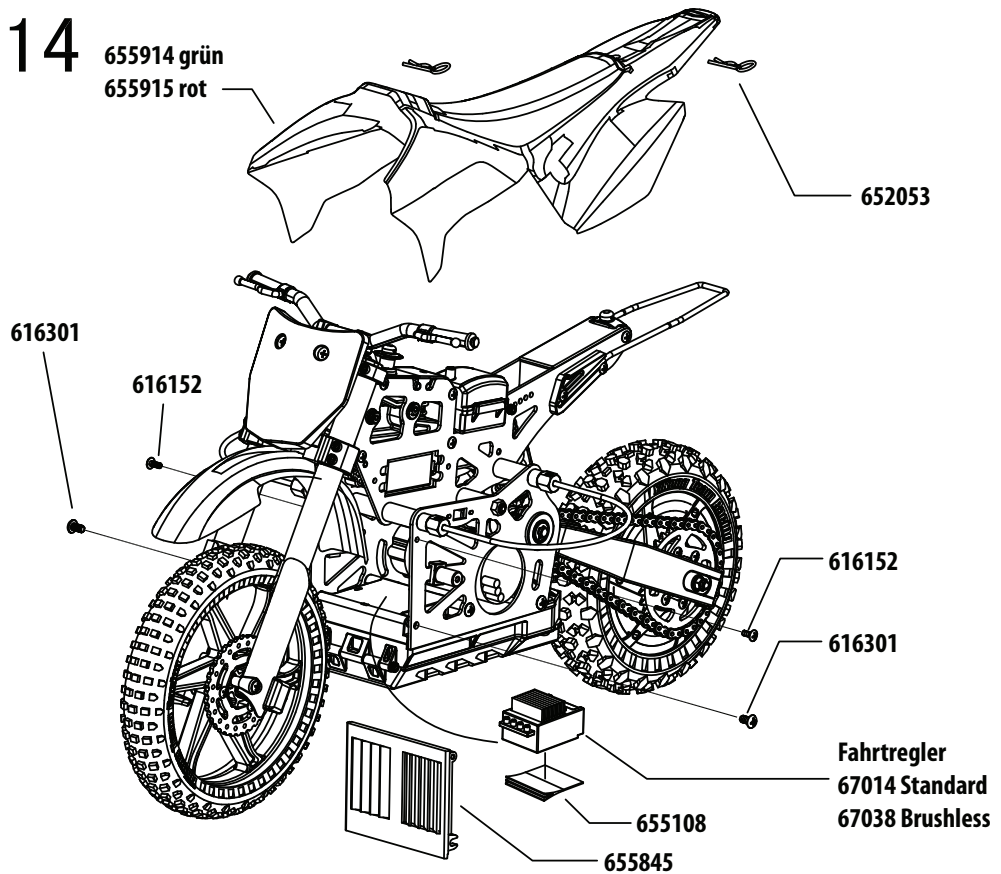



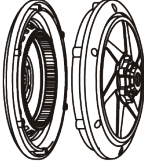



616301

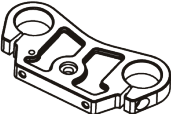
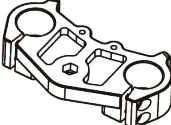

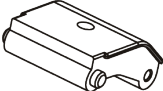
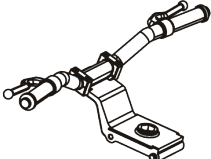

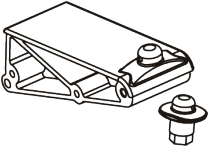
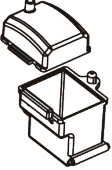
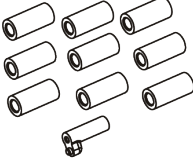

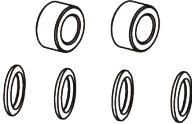
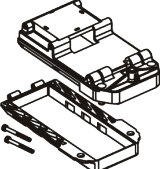
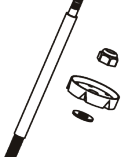



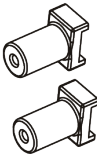
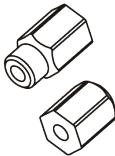
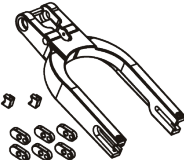
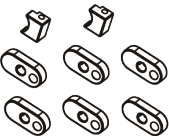
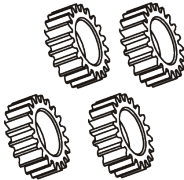
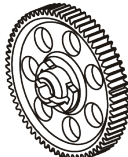

**Fahrtregler**  
 67014 Standard  
 67038 Brushless

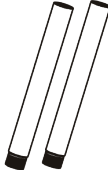
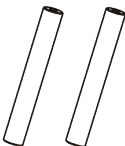

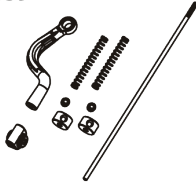
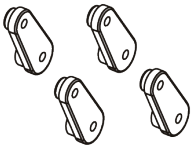
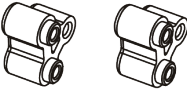
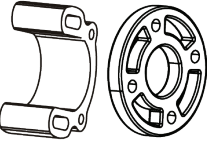

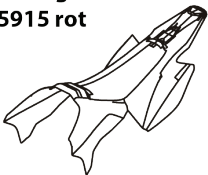

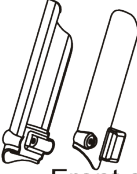

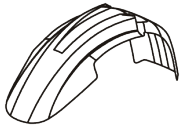

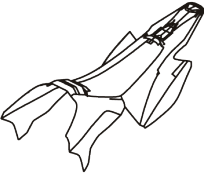

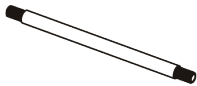
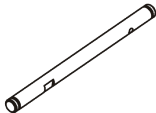
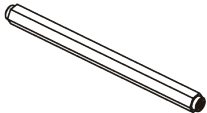

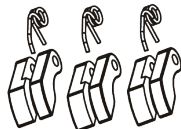

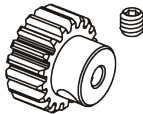
655108

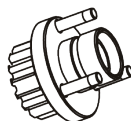
655845

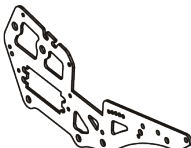

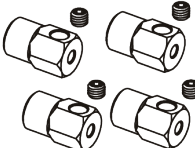
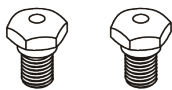

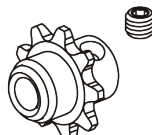

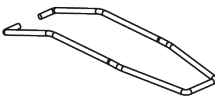
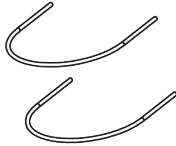



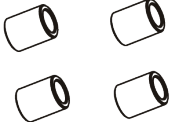
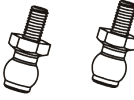

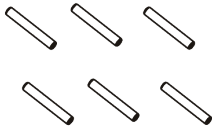
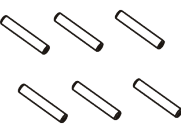
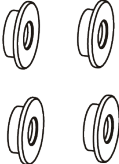
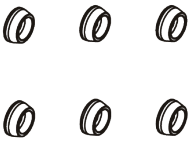
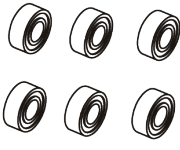
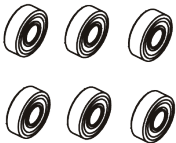
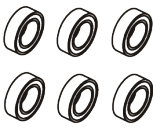
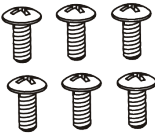

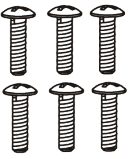
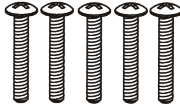
<p><b>655801</b></p>  <p>Gyro cover</p>	<p><b>655802</b></p>  <p>Rear rim – right</p>	<p><b>655803</b></p>  <p>Front rim</p>	<p><b>655804</b></p>  <p>Rear rim</p>
<p><b>655805</b></p>  <p>Rear tyre</p>	<p><b>655806</b></p>  <p>Front tyre</p>	<p><b>655807</b></p>  <p>Front tyre and rim set</p>	<p><b>655808</b></p>  <p>Rear tyre and rim set</p>
<p><b>655809</b></p>  <p>Brake disc</p>	<p><b>655810</b></p>  <p>Front upper suspension mount</p>	<p><b>655811</b></p>  <p>Front lower suspension mount</p>	<p><b>655812</b></p>  <p>Steering stem mount</p>
<p><b>655813</b></p>  <p>Side chassis bushing</p>	<p><b>655814</b></p>  <p>Front miffier mount</p>	<p><b>655815</b></p>  <p>Plastic handle</p>	<p><b>655816</b></p>  <p>Fender saver set</p>
<p><b>655817</b></p>  <p>Rear body mount</p>	<p><b>655818</b></p>  <p>Receiver case</p>	<p><b>655819</b></p>  <p>Chassis posts</p>	<p><b>655820</b></p>  <p>Front hub carrier</p>
<p><b>655821</b></p>  <p>Bushing</p>	<p><b>655822</b></p>  <p>Battery case</p>	<p><b>655823</b></p>  <p>Rear shock shaft</p>	<p><b>655824</b></p>  <p>Rear shock protection cover</p>





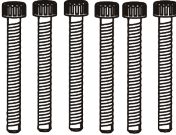

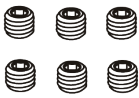







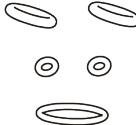

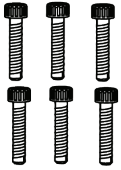
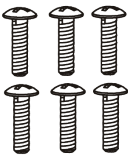
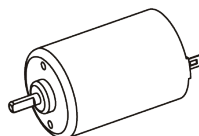
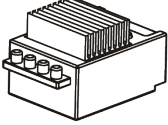
<p><b>655825</b></p>  <p>Rear shock set</p>	<p><b>655826</b></p>  <p>Rear shock cover</p>	<p><b>655827</b></p>  <p>Dummy holder</p>	<p><b>655828</b></p>  <p>Rear shock fixed block</p>
<p><b>655829</b></p>  <p>Swing arm</p>	<p><b>655830</b></p>  <p>Chain spacer</p>	<p><b>655831</b></p>  <p>20T Drive gear</p>	<p><b>655832</b></p>  <p>66T Spur gear</p>
<p><b>655833</b></p>  <p>Front shock Set</p>	<p><b>655834</b></p>  <p>Front spring set</p>	<p><b>655835</b></p>  <p>Front shock body</p>	<p><b>655836</b></p>  <p>Front shock axle</p>
<p><b>655837</b></p>  <p>Front shock lower cap</p>	<p><b>655838</b></p>  <p>Front shock upper cap</p>	<p><b>655839</b></p>  <p>Steering linkage set</p>	<p><b>655840</b></p>  <p>Servo arm</p>
<p><b>655841</b></p>  <p>Servo mount</p>	<p><b>655842</b></p>  <p>Motor mount</p>	<p><b>655843</b></p>  <p>Ball bearing bush</p>	<p><b>655914 grün</b> <b>655915 rot</b></p>  <p>PET body shell</p>
<p><b>655845</b></p>  <p>Front vent panel</p>	<p><b>655846</b></p>  <p>Front shock protection cover</p>	<p><b>655847</b></p>  <p>Front bumper</p>	<p><b>655916 grün</b> <b>655917 rot</b></p>  <p>Front rim fender</p>

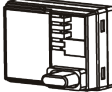
<p>655849</p>  <p>Body set</p>	<p>655850</p>  <p>Rear wheel axle</p>	<p>655851</p>  <p>Front wheel axle</p>	<p>655852</p>  <p>Chassis shaft</p>
<p>655853</p>  <p>Rear swing arm axle</p>	<p>655854</p>  <p>Battery case axle</p>	<p>655855</p>  <p>Steering shaft</p>	<p>655856</p>  <p>Clutch shoe and spring set</p>
<p>655857</p>  <p>Clutch springs- 0.8 &amp; 0.9mm</p>	<p>655858</p>  <p>64 Pitch pinion gear 19T</p>	<p>655859</p>  <p>Flywheel gyro</p>	<p>655860</p>  <p>Clutch gear - 15T</p>
<p>655861</p>  <p>Gear mount</p>	<p>655862</p>  <p>Upper side chassis</p>	<p>655863</p>  <p>Lower side chassis - right</p>	<p>655864</p>  <p>Lower side chassis - left</p>
<p>655865</p>  <p>Chassis lock nuts</p>	<p>655866</p>  <p>Downstop screws</p>	<p>655867</p>  <p>Sprocket plate</p>	<p>655868</p>  <p>Sprocket gear</p>
<p>655869</p>  <p>Rear shock spring</p>	<p>655870</p>  <p>Buffer spring</p>	<p>655871</p>  <p>Fender saver set</p>	<p>655872</p>  <p>Anti-roll bar</p>

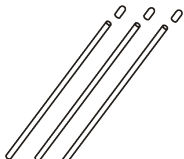
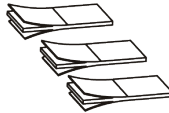

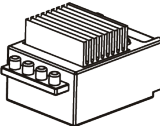
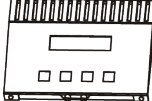
<p><b>655873</b></p>  <p>Chain</p>	<p><b>655874</b></p>  <p>Gear Bushing</p>	<p><b>655875</b></p>  <p>Steering ball stud</p>	<p><b>655876</b></p>  <p>M5.0 E-clip</p>
<p><b>655877</b></p>  <p>M2.5 X 15 pin</p>	<p><b>655878</b></p>  <p>M2.0 X 13 pin</p>	<p><b>655879</b></p>  <p>Rear wheel mount bushing</p>	<p><b>655880</b></p>  <p>Screw bushing</p>
<p><b>667763</b></p>  <p>Ball bearing 13 X 6 X 5mm</p>	<p><b>667765</b></p>  <p>Ball bearing 15 X 6 X 5mm</p>	<p><b>667761</b></p>  <p>Ball bearing 10 X 6 X 5mm</p>	<p><b>616152</b></p>  <p>3 X 8 Button head screws</p>
<p><b>616153</b></p>  <p>3 X 10 Button head screws</p>	<p><b>616151</b></p>  <p>3 X 12 Button head screws</p>	<p><b>616155</b></p>  <p>3 X 20 Button head screws</p>	<p><b>616303</b></p>  <p>4 X 8 Button head screws</p>
<p><b>616301</b></p>  <p>4 X 12 Socket head screws</p>	<p><b>616222</b></p>  <p>3 X 12 Socket head screws</p>	<p><b>616212</b></p>  <p>4 X 10 Socket head screws</p>	<p><b>616232</b></p>  <p>3 X 22 Socket head screws</p>
<p><b>616233</b></p>  <p>3 X 28 Socket head screws</p>	<p><b>616234</b></p>  <p>3 X 35 Socket head screws</p>	<p><b>616261</b></p>  <p>M4 X 4 Set screws</p>	<p><b>616271</b></p>  <p>M5 X 4 Set screws</p>

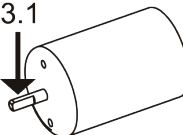

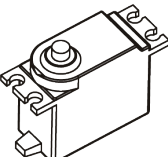



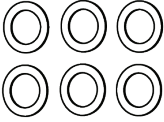



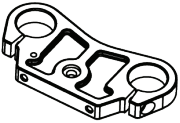
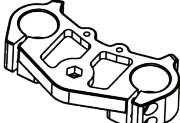
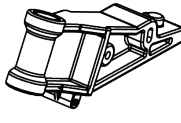
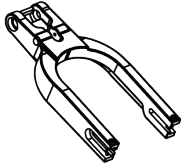
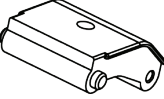

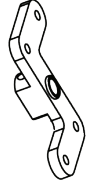
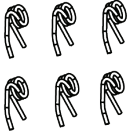



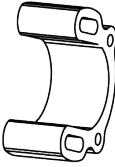
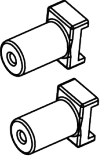
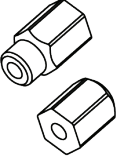
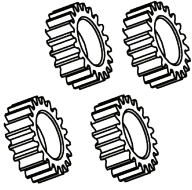
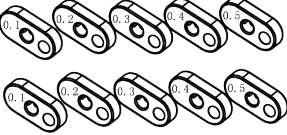

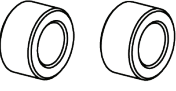
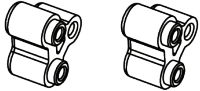
<p><b>51121</b></p>  <p>M2.5 Lock nut</p>	<p><b>616104</b></p>  <p>3 x 8 Flat head screws</p>	<p><b>616401</b></p>  <p>M3 Lock nut</p>	<p><b>616403</b></p>  <p>M4 Lock nut</p>
<p><b>616405</b></p>  <p>M5 Lock nut</p>	<p><b>655902</b></p>  <p>Full O-ring set</p>	<p><b>616214</b></p>  <p>4 X 20 Socket screws</p>	<p><b>616216</b></p>  <p>4 X 28 Socket screws</p>
<p><b>616213</b></p>  <p>4 X 16 Socket screws</p>	<p><b>616313</b></p>  <p>3 X 16 Button head screws</p>	<p><b>42137</b></p>  <p>High power 550 motor</p>	<p><b>655908</b></p>  <p>High power single way ESC</p>
<p><b>79098</b> (HTX-242T)</p>  <p>2.4G transmitter</p>	<p><b>79088</b> (HTX-RX)</p>  <p>2.4G receiver</p>	<p><b>79014</b> (HTX-242)</p>  <p>2.4G radio set</p>	<p><b>652967</b></p>  <p>Antenna tubes</p>
<p><b>655108</b></p>  <p>Double sided foam stick</p>	<p><b>652053</b></p>  <p>Body clips</p>	<p><b>67038</b></p>  <p>60A brushless ESC</p>	<p><b>79512 A3 Netzladegerät</b></p>  <p>Li-po charger</p>
<p><b>667224</b></p>  <p>Li-Po 7.4V battery</p>	<p><b>42402</b></p>  <p>3650KV3210 Brushless motor</p>	<p><b>667218</b></p>  <p>Ni-MH2000mAh 7.2V battery</p>	<p><b>79064</b></p>  <p>6KG servo</p>

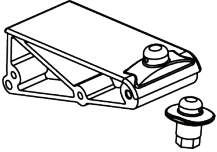
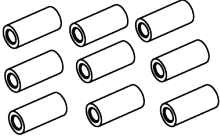
# Ersatzteil-Abbildungen HIMOTO Burstout Motorrad 1:4

<p><b>655955 montiert</b></p> 	<p><b>655922</b></p>  <p>9×6.1×0.3shim</p>		
---	---	--	--

## Tuningteile für HIMOTO Burstout Motorrad

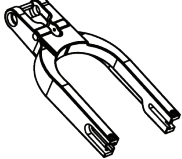
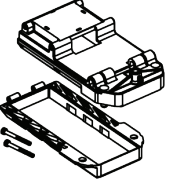
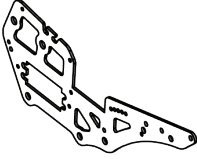
<p><b>655924</b></p>  <p>Aluminum front upper suspension mount</p>	<p><b>655925</b></p>  <p>Aluminum front lower suspension mount</p>	<p><b>655926</b></p>  <p>Aluminum steering stem mount</p>	<p><b>655927</b></p>  <p>Aluminum swing arm</p>
<p><b>655928</b></p>  <p>Aluminum front muffler mount</p>	<p><b>655929</b></p>  <p>Aluminum fender saver set</p>	<p><b>655930</b></p>  <p>Aluminum one-piece gear mount</p>	<p><b>655931</b></p>  <p>Clutch springs - 0.9mm</p>
<p><b>655932</b></p>  <p>Aluminum all bearing bush</p>	<p><b>655933</b></p>  <p>Aluminum rear shock set</p>	<p><b>655934</b></p>  <p>Aluminum front hub carrier</p>	<p><b>655935</b></p>  <p>Aluminum motor mount</p>
<p><b>655936</b></p>  <p>Aluminum dummy holder</p>	<p><b>655937</b></p>  <p>Aluminum rear shock fixed block</p>	<p><b>655938</b></p>  <p>Aluminum clutch gear - 15T</p>	<p><b>655939</b></p>  <p>Aluminum drive gear - 15T</p>
<p><b>655940</b></p>  <p>Aluminum chain spacer</p>	<p><b>655941</b></p>  <p>Aluminum bushing for 550 motor</p>	<p><b>655942</b></p>  <p>Aluminum front hub Bushing</p>	<p><b>655943</b></p>  <p>Aluminum servo mount</p>

<p><b>655944</b></p>  <p>Aluminum rear body mount</p>	<p><b>655945</b></p>  <p>Aluminum chassis posts</p>	<p><b>655946</b></p>  <p>Aluminum brake disc</p>	<p><b>Fahrerpuppe Bausatz</b>  <b>655920 grün</b>  <b>655921 rot</b></p>  <p>Spare dummy</p>
<p><b>655947</b></p>  <p>Carbon-look rear rim - left</p>	<p><b>655948</b></p>  <p>Carbon-look rear rim - right</p>	<p><b>655949</b></p>  <p>Carbon-look Front rim</p>	<p><b>655950</b></p>  <p>Carbon-look swing arm</p>
<p><b>655951</b></p>  <p>Carbon-look battery case</p>	<p><b>655952</b></p>  <p>Carbon upper side chassis</p>	<p><b>655953</b></p>  <p>Carbon lower side chassis -right</p>	<p><b>655954</b></p>  <p>Carbon lower side chassis -left</p>



**[www.himoto-krick.de](http://www.himoto-krick.de)**

Generalimporteur für Himoto Produkte

Krick Modelltechnik

Industriestrasse 1

75438 Knittlingen

Germany

E-Mail: [info@krick-modell.de](mailto:info@krick-modell.de)

Fax +49 (0)7043/31838