

# MEGA E

# Ersatzteilliste



**Off Road Truggy 1:10  
mit Elektroantrieb RTR**



**Truggy XT10 MegaE**  
**Bestell-Nr. 650042**



Technische Daten Truggy XT10MegaE

Modell	Länge	Breite	Höhe	Radstand	Bodenfreiheit	Untersetzung	Reifen-Ø	Reifenbreite	Fahrakku	Motor	Fernsteuerung
XT10	435 mm	320 mm	200 mm	275 mm	40 mm	8,8:1	125 mm	58 mm	7,2 V / 2000 mAh	RC550 Elektro	2,4 GHz 2 Kanäle

## Ausstattungsmerkmale





















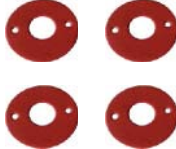



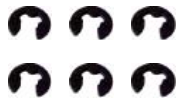

- 100% fahrfertig
- 4WD Antriebssystem
- Komplett kugelgelagert
- Kardanwellenantrieb
- Fahrakku 7,2V 2000 mAh
- Vier Öldruckstoßdämpfer mit Verschlusskappen aus eloxierten Aluminium
- Stoßdämpferfedern mit progressiver Federrate
- Stabiles Wannenchassis mit versenkten Schrauben an der Unterseite
- Liegendes Lenkservo und einstellbarer Servosaver
- HIMOTO Fahrtregler mit stufenloser Regelung für vor-/rückw. Fahrt und Bremse eingebaut
- Komplett ausgeschnittene, lackierte und dekorierte Karosserie
- High Grip Reifen auf stabilen Felgen verklebt
- Komplette Ausstattung mit Fernsteuerung, Akku und Ladegerät
- Kraftvoller RC550 Brushed Motor mit Gebläsekühlung

# www.himoto-krick.de

<p>Bestell-Nr. 650582 Karosserie MT Truggy</p> 	<p>Bestell-Nr. 654032 Antriebswelle mitte L 186,7 mm</p> 	<p>Bestell-Nr. 654005 Motorhalteplatte</p> 	<p>Bestell-Nr. 654088 Alu Querlenkerstifthalter v+h Set</p> <p>vorne</p>  <p>hinten</p> 
<p>Bestell-Nr. 654002 Diff.ausgang v/h (2)</p> 	<p>Bestell-Nr. 654003 Diff.-Eingangswelle vorne Set</p> 	<p>Bestell-Nr. 654004 Diff.-Eingangswelle hinten Set</p> 	<p>Bestell-Nr. 654006 Mitnehmer Diff.eingang (2)</p> 
<p>Bestell-Nr. 654033 Motorhalteplatte unten</p> 	<p>Bestell-Nr. 654075 Antriebswelle vorne Länge 90,4 mm</p> 	<p>Bestell-Nr. 654076 Antriebswelle hinten Länge 89,4 mm</p> 	<p>Bestell-Nr. 654007 Querlenkerstift v/h innen (2)</p> 
<p>Bestell-Nr. 654008 Querlenkerstift vorne aussen (2)</p> 	<p>Bestell-Nr. 654009 Querlenkerstift hinten aussen (2)</p> 	<p>Bestell-Nr. 654010 Lenkhebelachse (2)</p> 	<p>Bestell-Nr. 654077 Radachse vorne (2)</p> 
<p>Bestell-Nr. 654011 Radachse hinten (2)</p> 	<p>Bestell-Nr. 654079 Schraubensatz Getriebegehäuse</p> 	<p>Bestell-Nr. 654022 Schaftschrauben + Lager Lenkung</p> 	<p>Bestell-Nr. 654012 Lager Ackermannplatte (2)</p> 
<p>Bestell-Nr. 654052 Differential kpl</p> 	<p>Bestell-Nr. 654051 Diff.-Zahnräder kpl. Set</p> 	<p>Bestell-Nr. 654053 Lenkhebel B und Halterung Set</p> 	<p>Bestell-Nr. 654017 Diff. gehäuse + Wellen + Scheiben Set</p> 
<p>Bestell-Nr. 654015 Stoßdämpfer kurz kpl. (2)</p> 	<p>Bestell-Nr. 654016 Servogestänge Satz</p> 	<p>Bestell-Nr. 654086 Oberer Gestänge Satz vorne/hinten</p> 	<p>Bestell-Nr. 654087 Lenkgestänge Satz</p> 

<p>Bestell-Nr. 654090 Offroad Reifen Knobby (Paar)</p>	<p>Bestell-Nr. 654092 Offroad Felge Truggy (Paar)</p>	<p>Bestell-Nr. 654091 Offroad Truggy Radsatz kpl. (Paar)</p>	<p>Bestell-Nr. 654034 Chassis</p> 
<p>Bestell-Nr. 654035 Obere Abstützung</p> 	<p>Bestell-Nr. 654038 Akkualterung Set</p> 	<p>Bestell-Nr. 654041 Hauptzahnrad 69Z. + Motorhalterung</p> 	<p>Bestell-Nr. 654042 Abdeckung Hauptzahnrad</p> 
<p>Bestell-Nr. 654043 Ackermannplatte und Lenkhebel A Set</p> 	<p>Bestell-Nr. 654044 Servohalter + Servohebel Set</p> 	<p>Bestell-Nr. 654080 Querlenker vorne unten</p> 	<p>Bestell-Nr. 654081 Querlenker hinten unten</p> 
<p>Bestell-Nr. 654082 Achsschenkel vorne r/l</p>	<p>Bestell-Nr. 654083 Achsschenkel vorne r/l</p> 	<p>Bestell-Nr. 654084 Achsschenkelträger vorne r/l</p> 	<p>Bestell-Nr. 654085 Achsträger hinten r/l</p> 
<p>Bestell-Nr. 654013 Querlenkerstifthealter v+h</p> 	<p>Bestell-Nr. 654067 Getriebegehäuse vorne/ hinten MegaE</p>	<p>Bestell-Nr. 654074 Alu Stoßdämpferhalte- rung vorne/hinten Truggy</p>	<p>Bestell-Nr. 654014 Karosseriehalterset v/h MT</p> 
			<p>Bestell-Nr. 654059 Kugeln mit Bund Ø 4,8 mm (6)</p> 
<p>Bestell-Nr. 654060 Kugelkopf Ø 4,8mmxM3 kurz (8)</p> 	<p>Bestell-Nr. 654089 Kugelkopf Ø 4,8mm Boh- rung 3mm (8)</p> 	<p>Bestell-Nr. 667751 Kugellager 5x11x4 mm</p> 	<p>Bestell-Nr. 667789 Kugellager 10x15x4 mm</p> 

# Ersatzteilabbildungen MegaE Chassis

<p>Bestell-Nr. 616781 Karoseriesplinte groß 1:10 (12)</p> 	<p>Bestell-Nr. 616782 Karoseriesplinte klein 1:10 (12)</p> 	<p>Bestell-Nr. 616783 Akkuhaltesp lint (8)</p> 	<p>Bestell-Nr. 616400 Stoppmutter M2,5 (6)</p> 
<p>Bestell-Nr. 616401 Stopfmutter M3 (6)</p> 	<p>Bestell-Nr. 616403 Stopfmutter M4 mit Flansch (4)</p> 	<p>Bestell-Nr. 613247 Mitnehmerstift 2x10 mm</p> 	<p>Bestell-Nr. 654063 Felgenmitnehmer Hex12 (4)</p> 
<p>Bestell-Nr. 654064 Antennenrohr schwarz (2)</p> 	<p>Bestell-Nr. 654065 Karoserieschutzpads (12)</p> 	<p>Bestell-Nr. 654066 Motorpad (4)</p> 	<p>Bestell-Nr. 42137 Elektromotor RC550 mit Lüfter</p> 
<p>Bestell-Nr. 654062 Motorritzel 23 Zähne</p> 	<p>Bestell-Nr. 79058 Himoto Lenkservo Standardgröße</p> 	<p>Bestell-Nr. 667218 HIMOTO Racingpack 7,2V 2000 mAh mit Ta- miya Stecker</p> 	
<p>Bestell-Nr. 611680 Kabelbinder groß</p> 	<p>Bestell-Nr. 616854 E-Clips 4 (6)</p> 	<p>Bestell-Nr. 616852 E-Clips 2 (10)</p> 	<p>Bestell-Nr. 616152 Flachkopf-Schraube M3x8 mm (6)</p> 
<p>Bestell-Nr. 616105 Senkkopf-Schraube M3x8 mm (6)</p> 	<p>Bestell-Nr. 616186 Rundkopf-Schraube 2,5x14mm</p> 	<p>Bestell-Nr. 616252 Madenschraube M3x3 (6)</p> 	<p>Bestell-Nr. 616257 Madenschraube m. Schaft M3x3+2x7 (12)</p> 
<p>Bestell-Nr. 616267 Madenschraube M4x10 (12)</p> 	<p>Bestell-Nr. 616317 Flachkopf-Schraube M2.5x12 mm</p> 	<p>Bestell-Nr. 616502 Kreuzschlitz-Blechschr. mit Bund 3x10 (6)</p> 	<p>Bestell-Nr. 616511 Flachkopf-Blechschr- be 3x10 (6)</p> 



<p>Bestell-Nr. 616514 Verbindungs-Blech- schraube 3x12</p> 	<p>Bestell-Nr. 616518 Flachkopf-Blechschräu- be 2,6x8</p> 	<p>Bestell-Nr. 616517 Verbindungs-Blech- schraube 3x8</p> 	<p>Bestell-Nr. 616537 Rundkopf-Blechschräu- be 3x15</p> 
<p>Bestell-Nr. 616541 Senkkopf Blechschräu- be 3x10</p> 	<p>Bestell-Nr. 616547 Senkkopf Blechschräu- be 3x12</p> 	<p>Bestell-Nr. 616548 Senkkopf Blechschräu- be 2,6x12</p> 	<p>Bestell-Nr. 616519 Rundkopf-Blechschräu- be 3x37</p> 
<p>Bestell-Nr. 616549 Senkkopf Blechschräu- be 3x37</p> 	<p>Bestell-Nr. 616101 Senkkopf-Schräu- be M3x10 mm</p> 	<p>Bestell-Nr. 79085 Empfänger 2,4 GHz 3 K. mit Failsafefunktion</p> 	<p>Bestell-Nr. 67027 HIMOTO Fahrtregerl LS- 4150D</p> 
<p>Bestell-Nr. 79517 Ladegerät 220 V für 7,2V Akkus</p> 	<p>Bestell-Nr. 79095 Himoto Sender 2 Kanal 2.4 GHz</p> 	<p>Bestell-Nr. 613050 Kabelbinder klein</p> 	<p>Bestell-Nr. 667654 Motorkühlkörper Alu für 540 + 550 + 600</p> 

Tuningteile und weiteres Zubehör

<p>Bestell-Nr. 654107 Differentialzahnrad- satz innen Metallguss</p> 	<p>Bestell-Nr. 654108 Differential Metallversion- kpl. montiert Metallguss</p> 	<p>Bestell-Nr. 654109 Hauptzahnrad und Motorritzel Stahl</p> 	<p>Bestell-Nr. 654106 Differentialkegel- und Tellerrad Metallguss</p> 
<p>Bestell-Nr. 617440 Kreuzschlüssel 4, 5, 5.5, 7 mm</p> 	<p>Bestell-Nr. 67034 Programmcard für Brushless Speed Controller 60A Nr. 67033</p> 	<p>Bestell-Nr. 79511 Himoto Schnellladegerät BC6 12V max. 5 Ah</p> 	<p>Bestell-Nr. 67081 Himoto Netzteil 230V für HIMOTO Lader B6C</p> 

## Explosionszeichnung Lenkung MegaE

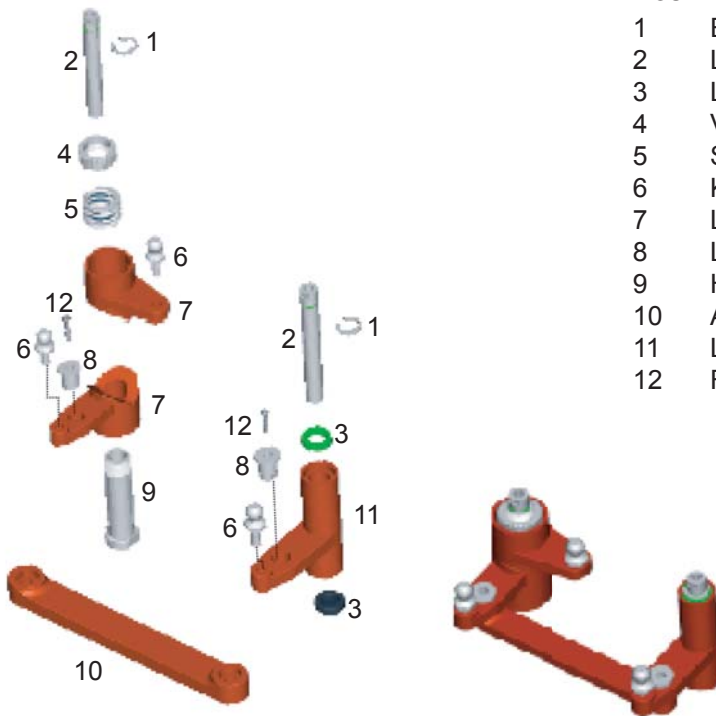

Pos.	Artikelbezeichnung	Bestell-Nr.
1	E-Clips 4	616854
2	Lenkhebelachse	654010
3	Lager	654043
4	Verstellmutter	654053
5	Servosaverfeder	654053
6	Kugelpopf Ø 4,8mm	654060
7	Lenkhebel B	654053
8	Lager Ackermannverbinder	654012
9	Halterung	654053
10	Ackermannplatte	654043
11	Lenkhebel A	654043
12	Flachkopf-Schraube M2,5x12 mm	616317

## Explosionszeichnung Differentiale MegaE



Pos.	Artikelbezeichnung	Bestell-Nr.
	Differential kpl	654052
1	Diff.ausgang v/h (2) MegaE	654002
2	Kugellager 10x15x4 mm	667789
3	Schrauben 2x9 mm	
4	Tellerrad groß	654051
5	O-Ring	654017
6	Scheibe groß	654017
7	Mitnehmerstift	654017
8	Zahnrad groß	654051
9	Scheibe klein	654017
10	Zahnrad klein	654051
11	Führungsstifte	654017
12	E-Clip	616852
13	Kegelrad	654051
14	Eingangswelle vorne	654003
14	Eingangswelle hinten	654004
15	Kugellager 5x11x4 mm	667751
16	Diff.gehäuse	654017

Pos.	Artikelbezeichnung	Bestell-Nr.	Pos.	Artikelbezeichnung	Bestell-Nr.
1a-1c	Stoßfänger vorne/hinten	654082	54	Empfänger 2,4 GHz 3 Kanäle	79085
2	Kugeln mit Bund Ø 4,8 mm	654059	55	Alu Querlenkerstifthalter hinten	654088
3	Stoßdämpfer kpl. (Paar)	654015	56	Getriebegehäuse vorne oder hinten	654067
4	Kugelkopf Ø 4,8mm Bohrung 3 mm	654089	57	Querlenkerstifthalter KS hinten	654013
5	Alu Stoßdämpferhalteplatte	654074	58	Radachse hinten	654011
6	Karossieriehalter	654014	59	Achsträger hinten	654085
7	Alu Querlenkerstifthalter vorne	654088	60	Querlenkerstift hinten aussen	654009
8	Getriebegehäuse vorne oder hinten	654067	61	Querlenker hinten unten	654081
9	Querlenkerstifthalter vorne	654013	62	Alu Stoßdämpferhalterung hinten	654074
10	Antriebswelle vorne	654075	63	Stoßfänger hinten	654082
11	Radachse vorne	654077	64	Oberer Querlenker hinten einstellbar (2)	654086
12	Kugellager 5x11x4 mm	667751	65	Stoßdämpfer kpl. (2)	654015
13	Achsschenkelträger vorne	654084	66	Stoßfänger hinten	654023
14	Lager Lenkung	654078			
15	Stoppmuttern M3	616401			
16	Kugelkopf Ø 4,8mm M3 kurz	654060			
17	Achsschenkel vorne	654083			
18	Schaftschrauben	654078			
19	Mitnehmerstift 2x10 mm	613247			
20	Felgenmitnehmer Hex12	654063			
21	Truggy Felgen (Paar)	654092			
22	Truggy Reifen Knobby m. Einlagen	654090			
21+22	Truggy Radsatz kpl. (Paar)	654091			
23	Radmutter M4 mit Flansch	616403			
24	Querlenkerstift v/h innen	654007			
25	Querlenker vorne unten	654080			
26	E-Clips 2	616852			
27	Querlenkerstift vorne aussen	654008			
28	Oberer Querlenker vorne einstellbar (2)	654086			
29	Stoppmutter M3	616401			
30	Mitnehmer Differentialeingang	654006			
31	Antriebswelle mitte	654032			
32	U-Scheibe 1	654004			
33	Hauptzahnrad 69 Zähne	654041			
34	U-Scheibe 2	654004			
35	Servogestänge Satz	654016			
36	Servohalter	654044			
37	Servohebel	654044			
38	Himoto Lenkservo 3 kg	79058			
39	Elektromotor RC550 mit Lüfter	42137			
TT	Brushless Motor 9.5T Sensor	42400			
40	Motorhalteplatte	654005			
41	Motorhalterung	654041			
42	Dichtung				
43	Motorritzel 23 Zähne	654062			
TT	Motorritzel 21 Zähne (Bei BL Antrieb)	654070			
44	Lenkgestänge Satz	654087			
45	Explosionszeichnung Lenkung siehe rechte Seite				
46	Obere Abstützung	654035			
47	Akkualterung Platte	654038			
48	Akkualterung Pfosten	654038			
49	Fahrtregler LS-4150	67027			
TT	Brushless Regler 60A mit Lüfter	67033			
50	Fahrakku 7,2 V 2000 mAh	667218			
TT	Fahrakku 7,2 V 3000 mAh	667219			
51	Chassis	654034			
52	Motorhalteplatte unten	654033			
53	Abdeckung Hauptzahnrad	654042			

## Schrauben

Pos.	Artikelbezeichnung	Bestell-Nr.
S-1	Verbindungs-Blechschaube 3x12	616514
S-2	Rundkopf-Schraube 2,5x14mm	616186
S-3	Flachkopf-Blechschaube 3x10 (6)	616511
S-4	Flachkopf-Blechschaube 2,6x8	616518
S-5	Flachkopf-Blechschaube 3x37 (8)	616519
S-6	Rundkopf-Blechschaube 3x15	616537
S-7	Madenschraube M4x10 (12)	616267
S-8	Senkkopf Blechschaube 3x12	616547
S-9	Flachkopf-Schraube M2,5x12 mm	616317
S-10	Verbindungs-Blechschaube 3x8	616517
S-11	Schftmadenschr. M3x3+2x7 (12)	616257
S-12	Flachkopf-Schraube M3x8 mm (6)	616152
S-13	Madenschraube M3x3 (6)	616252
S-14	Senkkopf Blechschaube 3x37	616549
S-15	Senkkopf-Schraube M3x8 mm (6)	616105
S-16	Senkkopf Blechschaube 2,6x12	616548
S-17	Senkkopf-Schraube M3x10 mm (6)	616101

TT = Tuningteil

# Explosionszeichnung MegaE XT10 Truggy

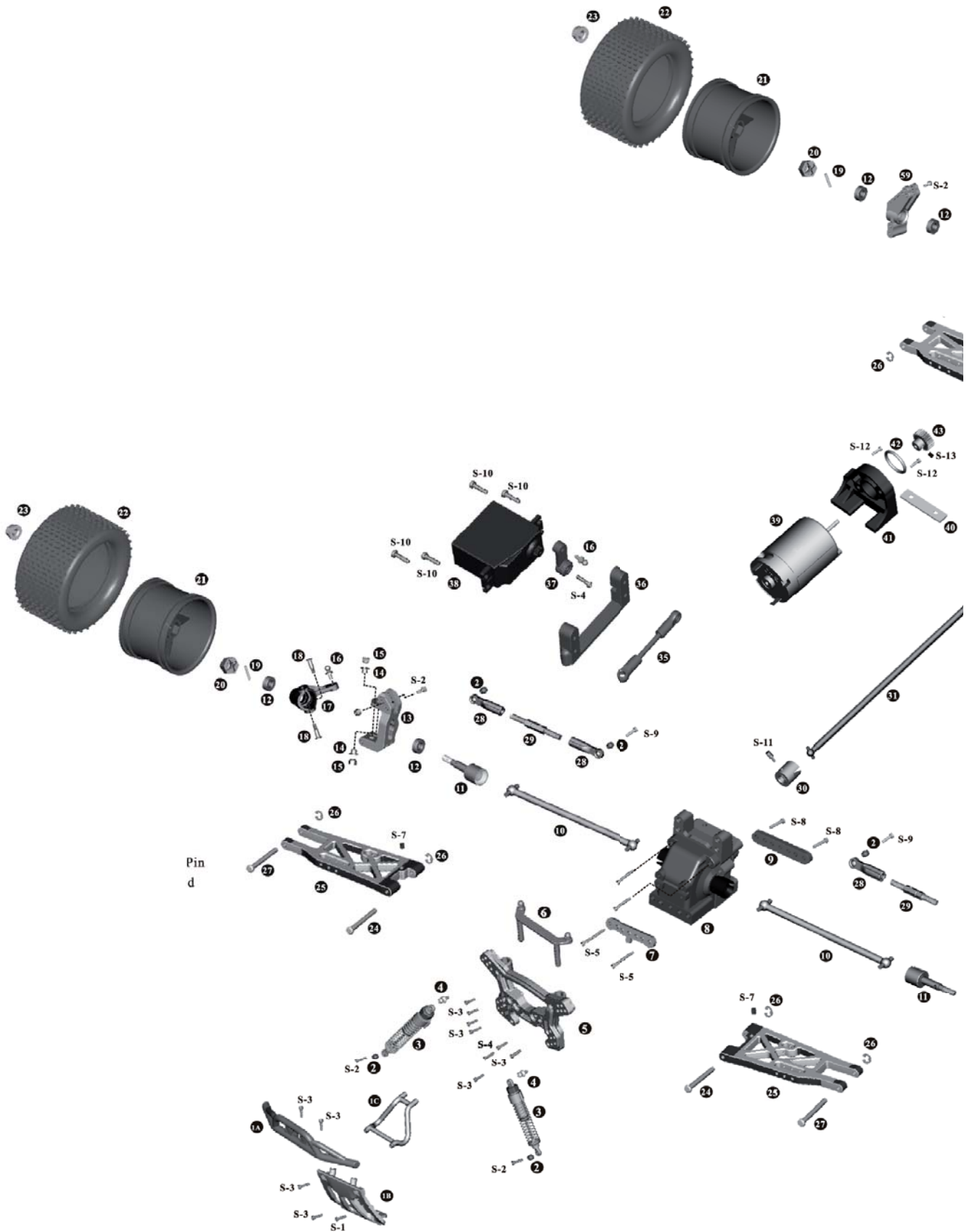



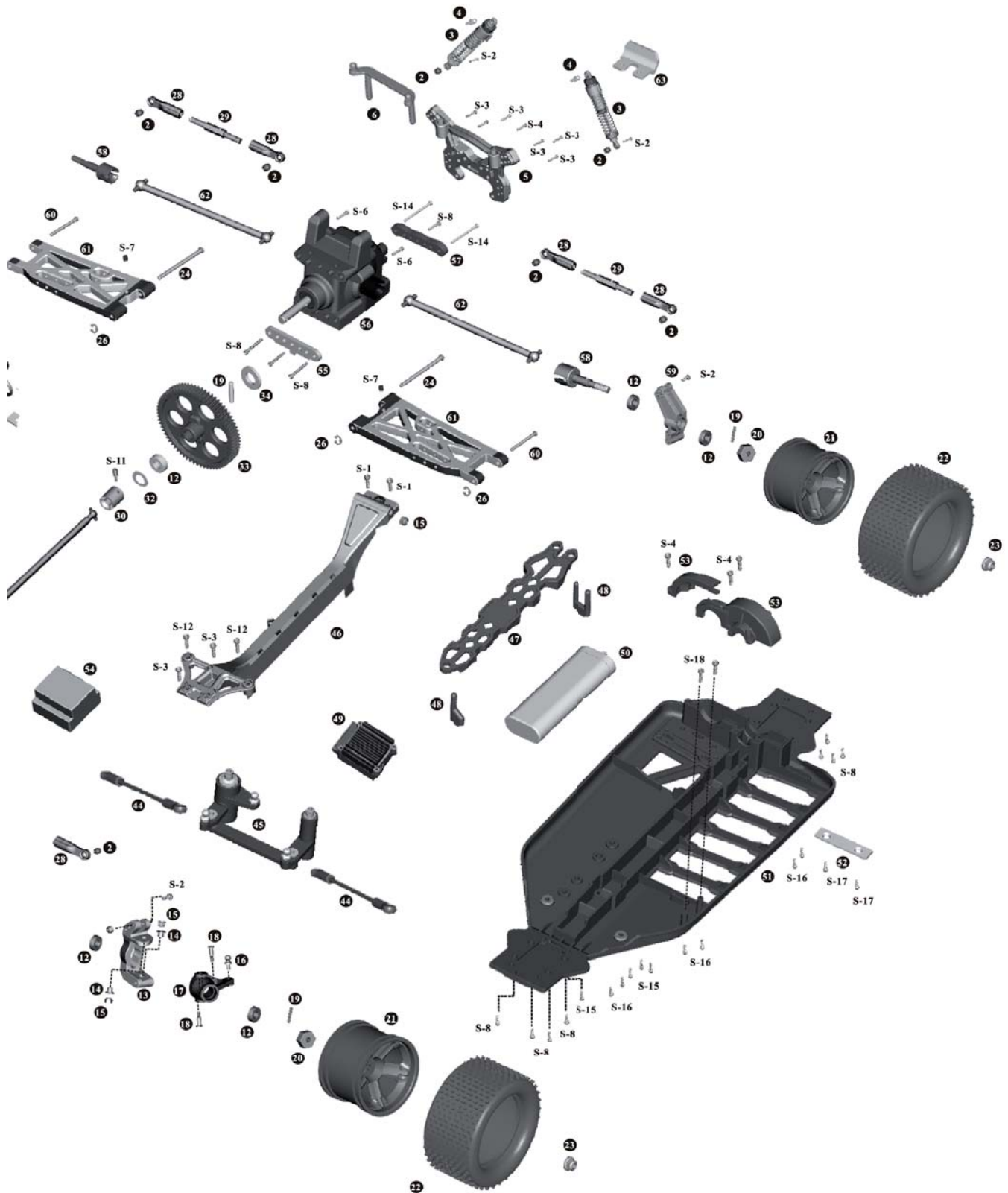



**[www.himoto-krick.de](http://www.himoto-krick.de)**

Generaldistributor für Himoto Produkte

Krick Modelltechnik

Industriestrasse 1

75438 Knittlingen

Germany

E-Mail: [info@krick-modell.de](mailto:info@krick-modell.de)

Fax +49 (0)7043/31838