

MEGA E



1:10 ELECTRIC 4WD RTR MODEL

Buggy XB10 MegaE
Bestell-Nr. 650041
Buggy XB10 Brushless
Version MegaE
Bestell-Nr. 650051

Monstertruck
MT10 MegaE
Bestell-Nr. 650043
MT10 Brushless
Version MegaE
Bestell-Nr. 650053

Technische Daten MegaE Serie Buggy XB10 und Monstertruck MT10

| Modell | Länge | Breite | Höhe | Radstand | Bodenfreiheit | Untersetzung | Reifen-Ø | Reifenbreite | Fahrakku | Motor | Fernsteuerung |
|--------|--------|--------|--------|----------|---------------|--------------|----------|-----------------------------|----------|---------|---------------------|
| XB10 | 405 mm | 245 mm | 155 mm | 275 mm | 18 mm | 8,8:1 | 84 mm | 34 mm vorne 40 mm hinten | 7,2 V | Elektro | 2,4 GHz 2 Kanäle |
| MT10 | 400 mm | 320 mm | 200 mm | 275 mm | 40 mm | 8,8:1/9,6:1 | 126 mm | 60 mm | 7,2 V | Elektro | 2,4 GHz 2 Kanäle |

Ausstattungsmerkmale

- 100% fahrfertig
- 4WD Antriebssystem
- Komplett kugelgelagert
- Kardanwellenantrieb
- Fahrakku 7,2V 2000 mAh bzw. 3000mAh bei der Brushlessversion
- Vier Öldruckstoßdämpfer mit Verschlusskappen aus eloxierten Aluminium
- Stoßdämpferfedern mit progressiver Federrate
- Stabiles Wannenchassis mit versenkten Schrauben an der Unterseite
- Liegendes Lenkservo und einstellbarer Servosaver
- HIMOTO Fahrtregler mit stufenloser Regelung für vor-/rückw. Fahrt und Bremse eingebaut
- Komplett ausgeschnittene, lackierte und dekorierte Karosserie
- High Grip Reifen auf stabilen Felgen verklebt
- Komplett Ausstattung mit Fernsteuerung, Akku und Ladegerät
- Wahlweise mit Brushed Motor oder Brushless Motor erhältlich

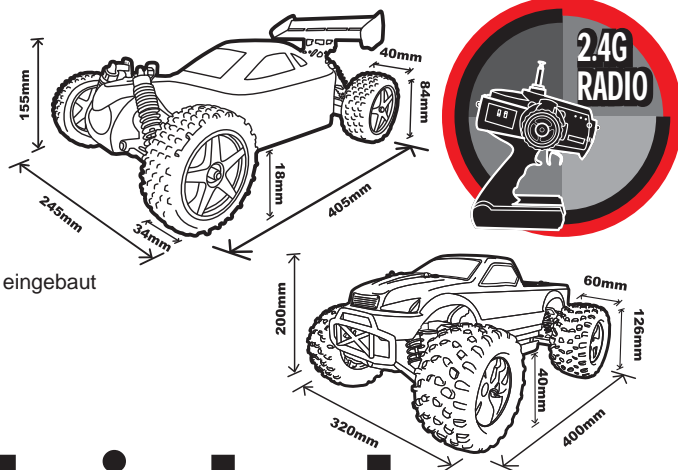



























www.himoto-krick.de

| | | | |
|--|---|---|--|
| <p>Bestell-Nr. 650877 Buggy Karosserie rot</p>  | <p>Bestell-Nr. 650878 Buggy Karosserie gelb</p>  | <p>Bestell-Nr. 650879 Buggy Karosserie grün</p>  | <p>Bestell-Nr. 650582 Karosserie MT Truggy</p>  |
| <p>Bestell-Nr. 650588 Karosserie MT Truck schwarz</p>  | <p>Bestell-Nr. 650589 Karosserie MT Truck rot</p>  | <p>Bestell-Nr. 650590 Karosserie MT Truck blau</p>  | <p>Bestell-Nr. 654001 Alu Querlenkerstifthalter v+h Set</p>  <p>vorne</p> <p>hinten</p> |
| <p>Bestell-Nr. 654002 Diff.ausgang v/h (2)</p>  | <p>Bestell-Nr. 654003 Diff.-Eingangswelle vorne Set</p>  | <p>Bestell-Nr. 654004 Diff.-Eingangswelle hinten Set</p>  | <p>Bestell-Nr. 654005 Motorhalteplatte</p>  |
| <p>Bestell-Nr. 654006 Mitnehmer Diff.eingang (2)</p>  | <p>Bestell-Nr. 654007 Querlenkerstift v/h innen (2)</p>  | <p>Bestell-Nr. 654008 Querlenkerstift vorne aussen (2)</p>  | <p>Bestell-Nr. 654009 Querlenkerstift hinten aussen (2)</p>  |
| <p>Bestell-Nr. 654010 Lenkhebelachse (2)</p>  | <p>Bestell-Nr. 654011 Radachse hinten (2)</p>  | <p>Bestell-Nr. 654012 Lager Ackermannplatte (2)</p>  | <p>Bestell-Nr. 654013 Querlenkerstifthalter v+h</p>  |
| <p>Bestell-Nr. 654014 Karosseriehalterset v/h MT</p>  | <p>Bestell-Nr. 654015 Stoßdämpfer kurz kpl. (2)</p>  | <p>Bestell-Nr. 654016 Servogestänge Satz</p>  | <p>Bestell-Nr. 654017 Diff. gehäuse + Wellen + Scheiben Set</p>  |
| <p>Bestell-Nr. 654018 Stoßdämpfer lang kpl. (2)</p>  | <p>Bestell-Nr. 654019 Alu Stoßdämpferhalterung v/h MT</p>  | <p>Bestell-Nr. 654020 Antriebswelle v/h Länge 79,9 mm</p>  | <p>Bestell-Nr. 654021 Radachse vorne (2)</p>  |



| | | | |
|---|---|---|--|
| <p>Bestell-Nr. 654022 Schaftschrauben + Lager Lenkung</p>  | <p>Bestell-Nr. 654023 Stoßfänger v+h Set Buggy</p>  | <p>Bestell-Nr. 654024 Querlenker vorne unten</p>  | <p>Bestell-Nr. 654025 Querlenker hinten unten</p>  |
| <p>Bestell-Nr. 654026 Achsschenkel vorne r/l</p>  | <p>Bestell-Nr. 654027 Achsschenkelträger vorne r/l</p>  | <p>Bestell-Nr. 654028 Achsträger hinten r/l</p>  | <p>Bestell-Nr. 654029 Karosseriehalter v+h Set Buggy</p>  |
| <p>Bestell-Nr. 654030 Heckspoilerhalterung Set Buggy</p>  | <p>Bestell-Nr. 654071 Heckspoiler Buggy</p>  | <p>Bestell-Nr. 654032 Antriebswelle mit- te L 186,7 mm</p>  | <p>Bestell-Nr. 654033 Motorhalterplatte unten</p>  |
| <p>Bestell-Nr. 654034 Chassis</p>  | <p>Bestell-Nr. 654035 Obere Abstützung</p>  | <p>Bestell-Nr. 654036 Stoßdämpferhalteplatte vorne Buggy</p>  | <p>Bestell-Nr. 654037 Stoßdämpferhalteplatte hinten Buggy</p>  |
| <p>Bestell-Nr. 654038 Akkualterung Set</p>  | <p>Bestell-Nr. 654039 Obere Querlenker je 2x</p> <p>vorne 69,7 mm</p> <p>hinten 74 mm</p>  | <p>Bestell-Nr. 654040 Lenkgestänge (2)</p>  | <p>Bestell-Nr. 654041 Hauptzahnrad 69Z. + Motorhalterung</p>  |
| <p>Bestell-Nr. 654042 Abdeckung Hauptzahn- rad</p>  | <p>Bestell-Nr. 654043 Ackermannplatte und Lenkhebel A Set</p>  | <p>Bestell-Nr. 654044 Servohalter + Servohe- bel Set</p>  | <p>Bestell-Nr. 654045 Offroad Pin Reifen vorne (2) Buggy</p>  |
| <p>Bestell-Nr. 654046 Offroad Pin Reifen hinten (2) Buggy</p>  | <p>Bestell-Nr. 654047 Offroad Felge vorne (2) Buggy</p>  | <p>Bestell-Nr. 654048 Offroad Felge hinten (2) Buggy</p>  | <p>Bestell-Nr. 654049 Offroad Radsatz kpl. vorne (2) Buggy</p>  |

Ersatzteilabbildungen MegaE Chassis

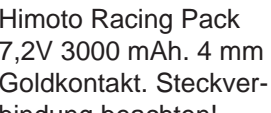
| | | | |
|---|---|---|---|
| <p>Bestell-Nr. 654050 Offroad Radsatz kpl. hinten (2) Buggy</p>  | <p>Bestell-Nr. 654051 Diff.-Zahnräder kpl. Set</p>  | <p>Bestell-Nr. 654052 Differential kpl</p>  | <p>Bestell-Nr. 654053 Lenkhebel B und Halte- rung Set</p>  |
| <p>Bestell-Nr. 654056 MT Reifen 125x50mm mit Einlagen (2)</p>  | <p>Bestell-Nr. 654057 MT Felgen 2.2 (2)</p>  | <p>Bestell-Nr. 654058 MT Radsatz kpl. (2)</p>  | <p>Bestell-Nr. 654059 Kugeln mit Bund Ø 4,8 mm (6)</p>  |
| <p>Bestell-Nr. 654060 Kugelpfopf Ø 4,8mmxM3 kurz (8)</p>  | <p>Bestell-Nr. 654061 Kugelpfopf Ø 4,8mmxM3 lang (8)</p>  | <p>Bestell-Nr. 667751 Kugellager 5x11x4 mm</p>  | <p>Bestell-Nr. 667789 Kugellager 10x15x4 mm</p>  |
| <p>Bestell-Nr. 616781 Karosseriesplinte groß 1:10 (12)</p>  | <p>Bestell-Nr. 616782 Karosseriesplinte klein 1:10 (12)</p>  | <p>Bestell-Nr. 616783 Akkuhaltespilnt (8)</p>  | <p>Bestell-Nr. 616400 Stopfmutter M2,5 (6)</p>  |
| <p>Bestell-Nr. 616401 Stopfmuttern M3 (6)</p>  | <p>Bestell-Nr. 616403 Stopfmutter M4 mit Flansch (4)</p>  | <p>Bestell-Nr. 613247 Mitnehmerstift 2x10 mm</p>  | <p>Bestell-Nr. 654063 Felgenmitnehmer Hex12 (4)</p>  |
| <p>Bestell-Nr. 654064 Antennenrohr schwarz (2)</p>  | <p>Bestell-Nr. 654065 Karosserieschutzpads (12)</p>  | <p>Bestell-Nr. 654066 Motorpad (4)</p>  | <p>Bestell-Nr. 42136 Elektromotor RC540</p>  |
| <p>Bestell-Nr. 42137 Elektromotor RC550 mit Lüfter</p>  | <p>Bestell-Nr. 42402 Himoto Brushless Motor KV3215</p>  | <p>Bestell-Nr. 654062 Motorritzel 23 Zähne</p>  | <p>Bestell-Nr. 654070 Motorritzel 21 Zähne</p>  |

| | | | |
|--|---|---|---|
| <p>Bestell-Nr. 611680 Kabelbinder groß</p>  | <p>Bestell-Nr. 616854 E-Clips 4 (6)</p>  | <p>Bestell-Nr. 616852 E-Clips 2 (10)</p>  | <p>Bestell-Nr. 616152 Flachkopf-Schraube M3x8 mm (6)</p>  |
| <p>Bestell-Nr. 616105 Senkkopf-Schraube M3x8 mm (6)</p>  | <p>Bestell-Nr. 616186 Rundkopf-Schraube 2,5x14mm</p>  | <p>Bestell-Nr. 616252 Madenschraube M3x3 (6)</p>  | <p>Bestell-Nr. 616257 Madenschraube m. Schaft M3x3+2x7 (12)</p>  |
| <p>Bestell-Nr. 616267 Madenschraube M4x10 (12)</p>  | <p>Bestell-Nr. 616317 Flachkopf-Schraube M2.5x12 mm</p>  | <p>Bestell-Nr. 616502 Kreuzschlitz-Blechschr. mit Bund 3x10 (6)</p>  | <p>Bestell-Nr. 616511 Flachkopf-Blechschr. be 3x10 (6)</p>  |
| <p>Bestell-Nr. 616514 Verbindungs-Blechschr. 3x12</p>  | <p>Bestell-Nr. 616518 Flachkopf-Blechschr. be 2,6x8</p>  | <p>Bestell-Nr. 616517 Verbindungs-Blechschr. 3x8</p>  | <p>Bestell-Nr. 616537 Rundkopf-Blechschr. 3x15</p>  |
| <p>Bestell-Nr. 616541 Senkkopf Blechschr. 3x10</p>  | <p>Bestell-Nr. 616547 Senkkopf Blechschr. 3x12</p>  | <p>Bestell-Nr. 616548 Senkkopf Blechschr. 2,6x12</p>  | <p>Bestell-Nr. 616519 Rundkopf-Blechschr. 3x37</p>  |
| <p>Bestell-Nr. 616549 Senkkopf Blechschr. 3x37</p>  | <p>Bestell-Nr. 616101 Senkkopf-Schraube M3x10 mm</p>  | <p>Bestell-Nr. 79088 Empfänger 2,4 GHz 4 K. mit Failsafefunktion</p>  | <p>Bestell-Nr. 67028 HIMOTO Fahrtregler LS- 4150D</p>  |
| <p>Bestell-Nr. 67035 HIMOTO Brushless Speed Controller 80A</p>  | <p>Bestell-Nr. 79058 Himoto Lenkservo Standardgröße</p>  | <p>Bestell-Nr. 667218 HIMOTO Racingpack 7,2V 2000 mAh mit Ta- miya Stecker</p>  | <p>Bestell-Nr. 667220 Himoto Racing Pack 7,2V 3000 mAh. T-Plug Bestell-Nr. 667223 Himoto Racing Pack 7,2V 3000 mAh. 4 mm Goldkontakt. Steckver- bindung beachten!</p>  |

Ersatzteilabbildungen MegaE Chassis

| | | | |
|--|--|---|--|
| <p>Bestell-Nr. 79517 Ladegerät 220 V für 7,2V Akkus</p>  | <p>Bestell-Nr. 79098 Himoto Sender 2 Kanal FHSS 2.4 GHz</p> | <p>Bestell-Nr. 613050 Kabelbinder klein</p>  | <p>Bestell-Nr. 667654 Motorkühlkörper Alu für 540 + 550 + 600</p>  |
|--|--|---|--|

Tuningteile und weiteres Zubehör

| | | | |
|---|--|--|--|
| <p>Bestell-Nr. 654101 Oberer Querlenker vorne verstellbar Satz</p>  | <p>Bestell-Nr. 654102 Oberer Querlenker hinten verstellbar Satz</p>  | <p>Bestell-Nr. 654103 Einstellbares Lenkge- stänge Satz</p>  | <p>Bestell-Nr. 654106 Differentialkegel- und Tellerrad Metallguss</p>  |
| <p>Bestell-Nr. 654107 Differentialzahnrad- satz innen Metallguss</p>  | <p>Bestell-Nr. 654108 Differential Metallversion- kpl. montiert Metallguss</p>  | <p>Bestell-Nr. 654109 Hauptzahnrad und Motorritzel Stahl</p>  | <p>Bestell-Nr. 654110 Tuning Stoßdämpfer- halteplatte Buggy vorne</p>  |
| <p>Bestell-Nr. 654111 Tuning Stoßdämpfer- halteplatte Buggy hinten</p>  | <p>Bestell-Nr. 654112 Aluminium C-Hubs vorne blau eloxiert</p>  | <p>Bestell-Nr. 654113 Aluminium Achsschen- kel vorne blau eloxiert</p>  | <p>Bestell-Nr. 654114 Aluminium Achsträger hinten blau eloxiert</p>  |
| <p>Bestell-Nr. 654115 Stoßdämpferhalte- rung Alu gefräst Bug- gy vorne blau eloxiert</p>  | <p>Bestell-Nr. 654116 Stoßdämpferhalterung Alu gefräst Buggy hinten blau eloxiert</p>  | <p>Bestell-Nr. 654117 Tuning Stoßdämpfer Metall Buggy vorne</p>  | <p>Bestell-Nr. 654118 Tuning Stoßdämpfer Metall Buggy hinten</p>  |
| <p>Bestell-Nr. 617440 Kreuzschlüssel 4, 5, 5.5, 7 mm</p>  | | <p>Bestell-Nr. 79511 Himoto Schnellladegerät BC6 12V max. 5 Ah</p>  | <p>Bestell-Nr. 67081 Himoto Netzteil 230V für HIMOTO Lader B6C</p>  |

| Pos. | Artikelbezeichnung | Bestell-Nr. | Pos. | Artikelbezeichnung | Bestell-Nr. |
|-------|--|-------------|-------|---|-------------|
| 1 | Stoßfänger vorne | 654023 | 51 | Chassis | 654034 |
| 2 | Kugeln mit Bund Ø 4,8 mm | 654059 | 52 | Motorhalteplatte unten | 654033 |
| 3 | Stoßdämpfer vorne kurz kpl. | 654015 | 53 | Abdeckung Hauptzahnrad | 654042 |
| 4 | Stoßdämpferhalteplatte hinten | 654037 | 54 | Empfänger ohne Empfängerquarz | 79083 |
| 5 | Stoßdämpferhalteplatte vorne | 654036 | Pos. | Artikelbezeichnung | Bestell-Nr. |
| 6 | Karosseriehalter vorne | 654029 | 55 | Alu Querlenkerstifthalter hinten | 654001 |
| 7 | Alu Querlenkerstifthalter vorne | 654001 | 56 | Getriebegehäuse hinten | 654067 |
| 8 | Getriebegehäuse vorne | 654067 | 57 | Querlenkerstifthalter Kunststoff hinten | 654013 |
| 9 | Querlenkerstifthalter Kunststoff vorne | 654013 | 58 | Radachse hinten | 654011 |
| 10 | Antriebswelle vorne oder hinten | 654020 | 59 | Achsträger hinten | 654028 |
| 11 | Radachse vorne | 654021 | 60 | Offroad Felge hinten | 654048 |
| 12 | Kugellager 5x11x4 mm | 667751 | 61 | Offroad Pin Reifen hinten | 654046 |
| 13 | Achsschenkelträger vorne | 654027 | 60+61 | Offroad Radsatz kpl. Hinten | 654050 |
| 14 | Lager Lenkung | 654022 | 62 | Querlenkerstift hinten aussen | 654009 |
| 15 | Stoppmuttern M3 | 616401 | 63 | Karosseriehalter hinten | 654014 |
| 16 | Kugelkopf Ø 4,8mmxM3 kurz | 654060 | 65 | Karosseriehalter hinten | 654029 |
| 17 | Achsschenkel vorne | 654026 | 66 | Oberer Querlenker hinten einstellbar Satz Tuningteil | 654102 |
| 18 | Schaftschrauben | 654022 | 67 | Stoßdämpfer hinten lang kpl. | 654018 |
| 19 | Mitnehmerstift 2x10 mm | 613247 | 68 | Stoßfänger hinten | 654023 |
| 20 | Felgenmitnehmer Hex12 | 654063 | 69 | Heckspoilerhalterung Set Buggy | 654030 |
| 21 | Offroad Felge vorne | 654047 | 70 | Heckspoilerhalterung Set Buggy | 654030 |
| 22 | Offroad Pin Reifen vorne | 654045 | 71 | Heckspoilerhalterung Set Buggy | 654030 |
| 21+22 | Offroad Radsatz kpl. Vorne | 654049 | 72 | Heckspoilerhalterung Set Buggy | 654030 |
| 23 | Radmutter M4 mit Flansch | 616403 | 73 | Querlenkerstrebe vorne oben | 654039 |
| 24 | Querlenkerstift vorne oder hinten innen | 654007 | 74 | Querlenkerstrebe hinten oben | 654039 |
| 25 | Querlenker vorne unten | 654024 | 75 | Lenkgestänge | 654040 |
| 26 | E-Clips 2 | 616852 | | | |
| 27 | Querlenkerstift vorne aussen | 654008 | | | |
| 28 | Oberer Querlenker vorne einstellbar Satz Tuningteil | 654101 | | | |
| 29 | Stoppmutter M3 | 616401 | | | |
| 30 | Mitnehmer Diff.eingang | 654006 | | | |
| 31 | Antriebswelle mitte | 654032 | | | |
| 32 | U-Scheibe 1 | 654004 | | | |
| 33 | Hauptzahnrad 69 Zähne | 654041 | | | |
| 34 | U-Scheibe 2 | 654004 | | | |
| 35 | Servogestänge Satz | 654016 | | | |
| 36 | Servohalter | 654044 | | | |
| 37 | Servohebel | 654044 | | | |
| 38 | Himoto Lenkservo 3 kg | 79059 | | | |
| 39 | Elektromotor RC540 | 42136 | | | |
| bzw. | Brushless Motor 9.5T Sensor | 42400 | | | |
| 40 | Motorhalteplatte | 654005 | | | |
| 41 | Motorhalterung | 654041 | | | |
| 42 | Dichtung | | | | |
| 43 | Motorritzel 23 Zähne | 654062 | | | |
| 44 | Lenkgestänge verstellbar Satz Tuningteil | 654103 | | | |
| 45 | Siehe Explosionszeichnung Lenkung Seite 20 | | | | |
| 46 | Obere Abstützung MegaE | 654035 | | | |
| 47 | Akkuhalterung Platte | 654038 | | | |
| 48 | Akkuhalterung Pfosten | 654038 | | | |
| 49 | Fahrtregler | 67028 | | | |
| bzw. | Brushless Regler 80A mit Lüfter | 67035 | | | |
| 50 | Fahrakku 7,2 V 2000 mAh Tam. Stecker | 667218 | | | |
| bzw. | Fahrakku 7,2 V 3000 mAh Tam. Stecker | 667219 | | | |
| bzw. | Fahrakku 7,2 V 3000 mAh T-Plug | 667220 | | | |
| bzw. | Fahrakku 7,2 V 3000 mAh 4 mm GH | 667223 | | | |

Schrauben

| Pos. | Artikelbezeichnung | Bestell-Nr. |
|------|----------------------------------|-------------|
| S-1 | Verbindungs-Blechschaube 3x12 | 616514 |
| S-2 | Rundkopf-Schraube 2,5x14mm | 616186 |
| S-3 | Flachkopf-Blechschaube 3x10 (6) | 616511 |
| S-4 | Flachkopf-Blechschaube 2,6x8 | 616518 |
| S-5 | Flachkopf-Blechschaube 3x37 (8) | 616519 |
| S-6 | Rundkopf-Blechschaube 3x15 | 616537 |
| S-7 | Madenschraube M4x10 (12) | 616267 |
| S-8 | Senkkopf Blechschaube 3x12 | 616547 |
| S-9 | Flachkopf-Schraube M2,5x12 mm | 616317 |
| S-10 | Verbindungs-Blechschaube 3x8 | 616517 |
| S-11 | Madenschraube m. Schaft M3x3+2x7 | 616257 |
| S-12 | Flachkopf-Schraube M3x8 mm (6) | 616152 |
| S-13 | Madenschraube M3x3 (6) | 616252 |
| S-14 | Senkkopf Blechschaube 3x37 | 616549 |
| S-15 | Senkkopf-Schraube M3x8 mm (6) | 616105 |
| S-16 | Senkkopf Blechschaube 2,6x12 | 616548 |
| S-17 | Senkkopf-Schraube M3x10 mm (6) | 616101 |

Explosionszeichnung MegaE XB10 Buggy

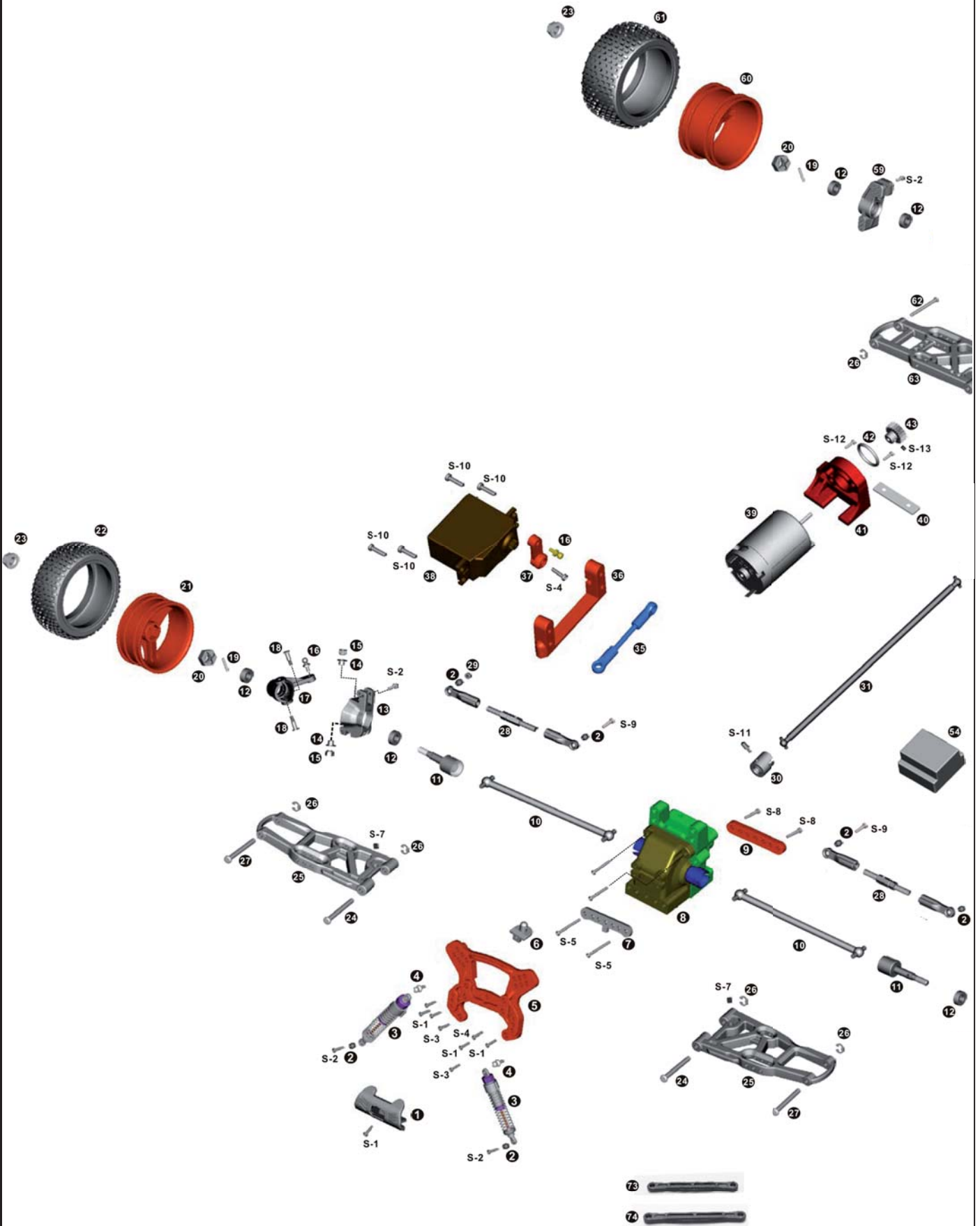

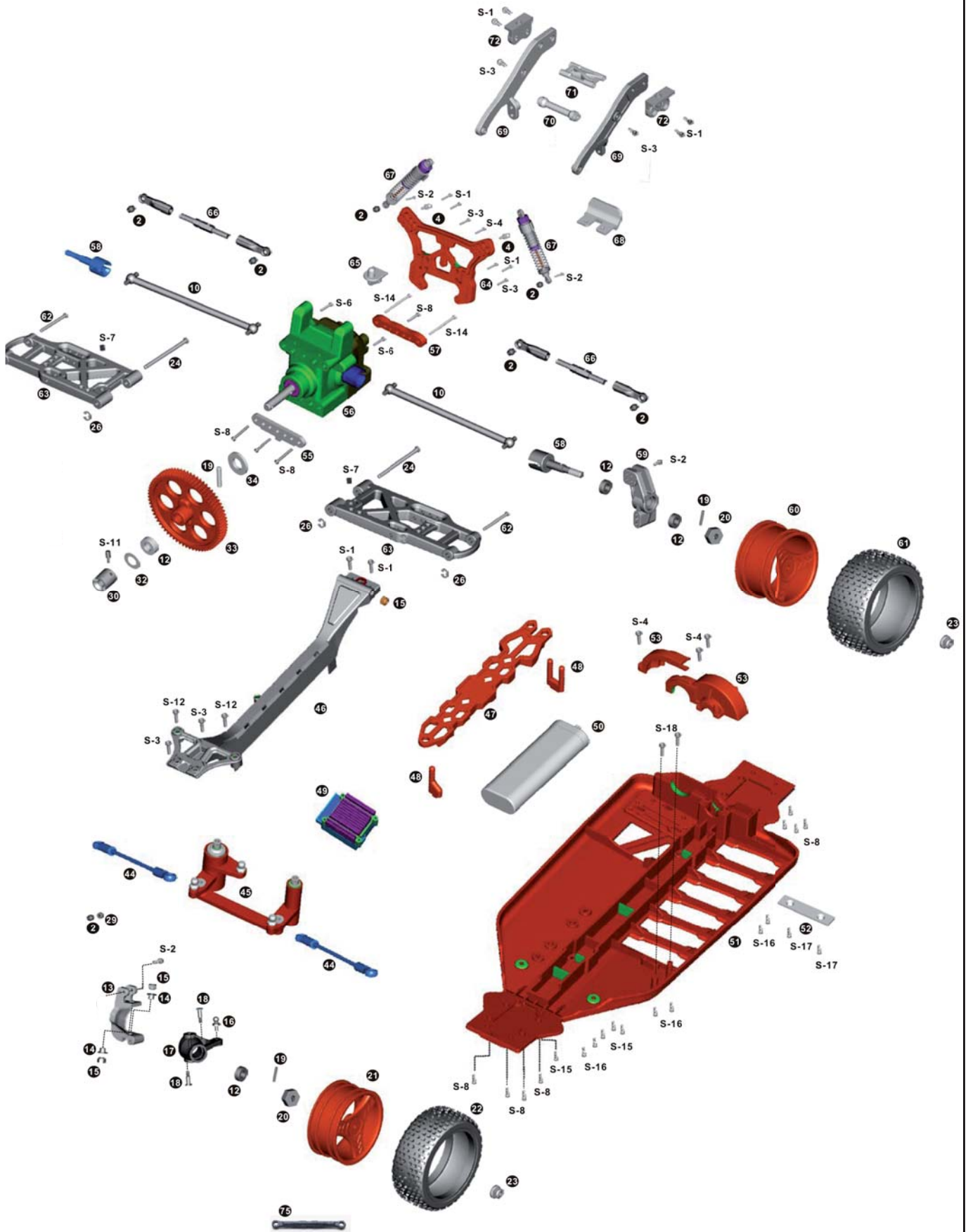

Explosionszeichnung Lenkung MegaE

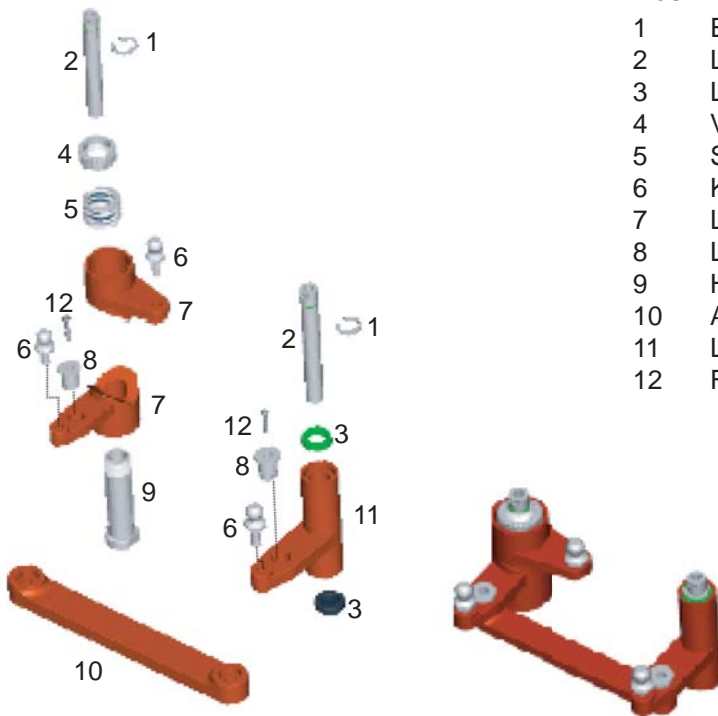

| Pos. | Artikelbezeichnung | Bestell-Nr. |
|------|-------------------------------|-------------|
| 1 | E-Clips 4 | 616854 |
| 2 | Lenkhebelachse | 654010 |
| 3 | Lager | 654043 |
| 4 | Verstellmutter | 654053 |
| 5 | Servosaverfeder | 654053 |
| 6 | Kugelkopf Ø 4,8mm | 654060 |
| 7 | Lenkhebel B | 654053 |
| 8 | Lager Ackermannverbinder | 654012 |
| 9 | Halterung | 654053 |
| 10 | Ackermannplatte | 654043 |
| 11 | Lenkhebel A | 654043 |
| 12 | Flachkopf-Schraube M2,5x12 mm | 616317 |

Explosionszeichnung Differentiale MegaE



| Pos. | Artikelbezeichnung | Bestell-Nr. |
|------|----------------------------|-------------|
| | Differential kpl | 654052 |
| 1 | Diff.ausgang v/h (2) MegaE | 654002 |
| 2 | Kugellager 10x15x4 mm | 667789 |
| 3 | Schrauben 2x9 mm | |
| 4 | Tellerrad groß | 654051 |
| 5 | O-Ring | 654017 |
| 6 | Scheibe groß | 654017 |
| 7 | Mitnehmerstift | 654017 |
| 8 | Zahnrad groß | 654051 |
| 9 | Scheibe klein | 654017 |
| 10 | Zahnrad klein | 654051 |
| 11 | Führungsstifte | 654017 |
| 12 | E-Clip | 616852 |
| 13 | Kegelrad | 654051 |
| 14 | Eingangswelle vorne | 654003 |
| 14 | Eingangswelle hinten | 654004 |
| 15 | Kugellager 5x11x4 mm | 667751 |
| 16 | Diff.gehäuse | 654017 |

| Pos. | Artikelbezeichnung | Bestell-Nr. | bzw. | Artikelbezeichnung | Bestell-Nr. |
|-------|--|-------------|------|---|-------------|
| | | | | Fahrakku 7,2 V 3000 mAh 4 mm GH | 667223 |
| 1 | Stoßfänger vorne | 654023 | 51 | Chassis | 654034 |
| 2 | Kugeln mit Bund Ø 4,8 mm | 654059 | 52 | Motorhalteplatte unten | 654033 |
| 3 | Stoßdämpfer lang kpl. | 654018 | 53 | Abdeckung Hauptzahnrad | 654042 |
| 4 | Kugelkopf Ø 4,8mmxM3 lang | 654061 | 54 | Empfänger ohne Empfängerquarz | 79083 |
| 5 | Alu Stoßdämpferhalterung vorne | 654019 | | | |
| 6 | Karosseriehalter vorne | 654014 | Pos. | Artikelbezeichnung | Bestell-Nr. |
| 7 | Alu Querlenkerstifthalter vorne | 654001 | 55 | Alu Querlenkerstifthalter hinten | 654001 |
| 8 | Getriebegehäuse vorne oder hinten | 654067 | 56 | Getriebegehäuse vorne oder hinten | 654067 |
| 9 | Querlenkerstifthalter vorne | 654013 | 57 | Querlenkerstifthalter KS hinten | 654013 |
| 10 | Antriebswelle vorne oder hinten | 654020 | 58 | Radachse hinten | 654011 |
| 11 | Radachse vorne | 654021 | 59 | Achsträger hinten | 654028 |
| 12 | Kugellager 5x11x4 mm | 667751 | 60 | Querlenkerstift hinten aussen | 654009 |
| 13 | Achsschenkelträger vorne | 654027 | 61 | Querlenker hinten unten | 654025 |
| 14 | Lager Lenkung | 654022 | 62 | Alu Stoßdämpferhalterung hinten | 654019 |
| 15 | Stoppmuttern M3 | 616401 | 63 | Karosseriehalter hinten | 654014 |
| 16 | Kugelkopf Ø 4,8mm M3 kurz | 654060 | 64 | Oberer Querlenker hinten einstellbar Satz | |
| 17 | Achsschenkel vorne | 654026 | | Tuningteil | 654102 |
| 18 | Schaftschrauben | 654022 | 65 | Stoßdämpfer lang kpl. (2) | 654018 |
| 19 | Mitnehmerstift 2x10 mm | 613247 | 66 | Stoßfänger hinten | 654023 |
| 20 | Felgenmitnehmer Hex12 | 654063 | 67 | Querlenkerstrebe vorne oben | 654039 |
| 21 | MT Felgen 2.2" | 654057 | 68 | Querlenkerstrebe hinten oben | 654039 |
| 22 | MT Reifen 125x50mm mit Einlagen | 654056 | 69 | Lenkgestänge | 654040 |
| 21+22 | MT Radsatz kpl. | 654058 | | | |
| 23 | Radmutter M4 mit Flansch | 616403 | | | |
| 24 | Querlenkerstift v/h innen | 654007 | | | |
| 25 | Querlenker vorne unten | 654024 | | | |
| 26 | E-Clips 2 | 616852 | | | |
| 27 | Querlenkerstift vorne aussen | 654008 | | | |
| 28 | Oberer Querlenker vorne einstellbar Satz | | | | |
| | Tuningteil | 654101 | | | |
| 29 | Stoppmutter M3 | 616401 | | | |
| 30 | Mitnehmer Differentialeingang | 654006 | | | |
| 31 | Antriebswelle mitte | 654032 | | | |
| 32 | U-Scheibe 1 | 654004 | | | |
| 33 | Hauptzahnrad 69 Zähne | 654041 | | | |
| 34 | U-Scheibe 2 | 654004 | | | |
| 35 | Servogestänge Satz | 654016 | | | |
| 36 | Servohalter | 654044 | | | |
| 37 | Servohebel | 654044 | | | |
| 38 | Himoto Lenkservo 3 kg | 79058 | | | |
| 39 | Elektromotor RC550 mit Lüfter | 42137 | | | |
| bzw. | Brushless Motor 9.5T Sensor | 42400 | | | |
| 40 | Motorhalteplatte | 654005 | | | |
| 41 | Motorhalterung | 654041 | | | |
| 42 | Dichtung | | | | |
| 43 | Motorritzel 23 Zähne | 654062 | | | |
| bzw. | Motorritzel 21 Zähne (Bei BL Antrieb) | 654070 | | | |
| 44 | Lenkgestänge verstellbar Satz | | | | |
| | Tuningteil | 654103 | | | |
| 45 | Explosionszeichnung Lenkung Seite 20 | | | | |
| 46 | Obere Abstützung | 654035 | | | |
| 47 | Akkualterung Platte | 654038 | | | |
| 48 | Akkualterung Pfosten | 654038 | | | |
| 49 | Fahrtregler | 67028 | | | |
| bzw. | Brushless Regler 80A mit Lüfter | 67035 | | | |
| 50 | Fahrakku 7,2 V 2000 mAh Tam. Stecker | 667218 | | | |
| bzw. | Fahrakku 7,2 V 3000 mAh Tam. Stecker | 667219 | | | |
| bzw. | Fahrakku 7,2 V 3000 mAh T-Plug | 667220 | | | |

Schrauben

| Pos. | Artikelbezeichnung | Bestell-Nr. |
|------|---------------------------------|-------------|
| S-1 | Verbindungs-Blechschaube 3x12 | 616514 |
| S-2 | Rundkopf-Schraube 2,5x14mm | 616186 |
| S-3 | Flachkopf-Blechschaube 3x10 (6) | 616511 |
| S-4 | Flachkopf-Blechschaube 2,6x8 | 616518 |
| S-5 | Flachkopf-Blechschaube 3x37 (8) | 616519 |
| S-6 | Rundkopf-Blechschaube 3x15 | 616537 |
| S-7 | Madenschraube M4x10 (12) | 616267 |
| S-8 | Senkkopf Blechschaube 3x12 | 616547 |
| S-9 | Flachkopf-Schraube M2,5x12 mm | 616317 |
| S-10 | Verbindungs-Blechschaube 3x8 | 616517 |
| S-11 | Schftmadenschr. M3x3+2x7 (12) | 616257 |
| S-12 | Flachkopf-Schraube M3x8 mm (6) | 616152 |
| S-13 | Madenschraube M3x3 (6) | 616252 |
| S-14 | Senkkopf Blechschaube 3x37 | 616549 |
| S-15 | Senkkopf-Schraube M3x8 mm (6) | 616105 |
| S-16 | Senkkopf Blechschaube 2,6x12 | 616548 |
| S-17 | Senkkopf-Schraube M3x10 mm (6) | 616101 |

Explosionszeichnung MegaE MT10 Monstertruck

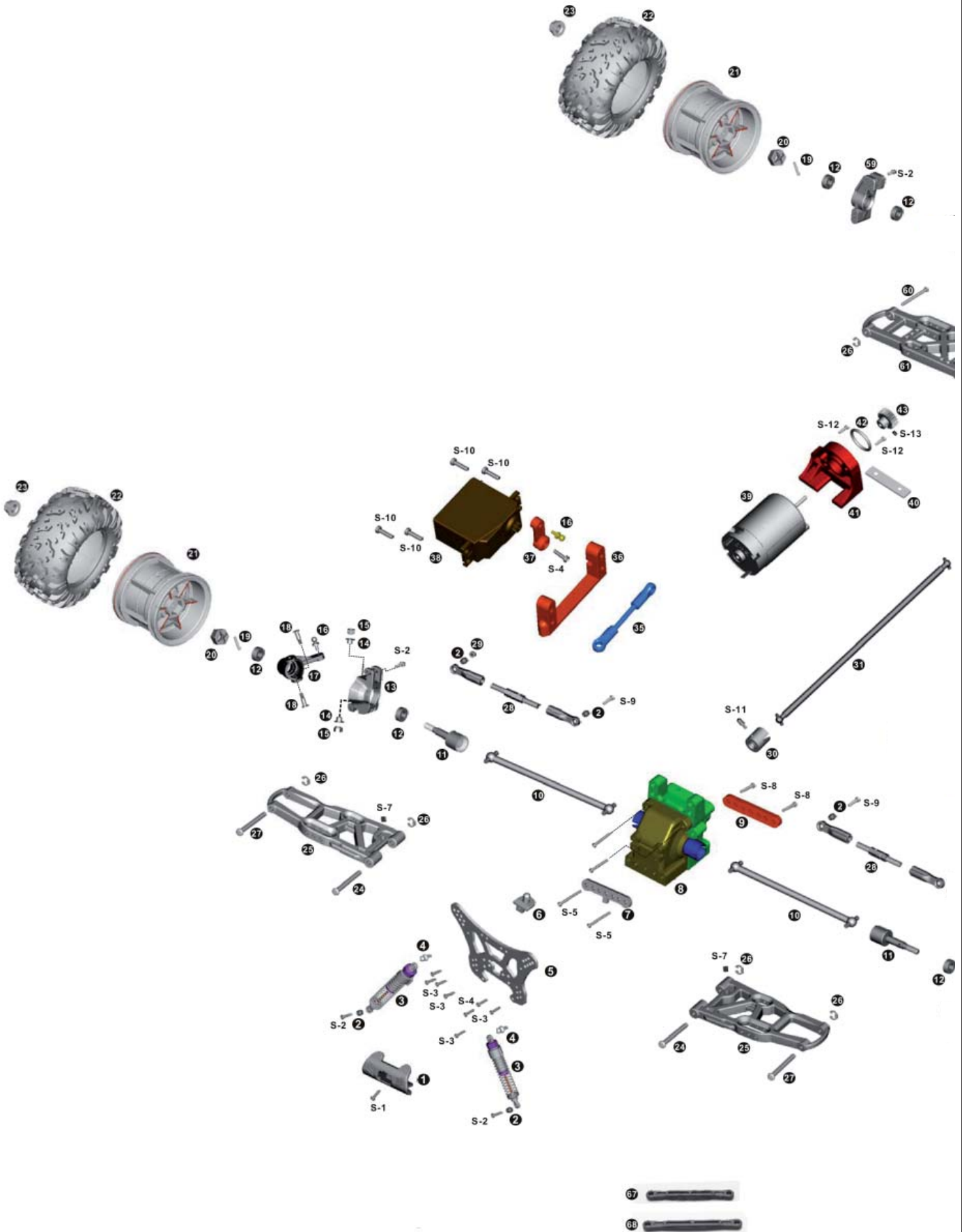

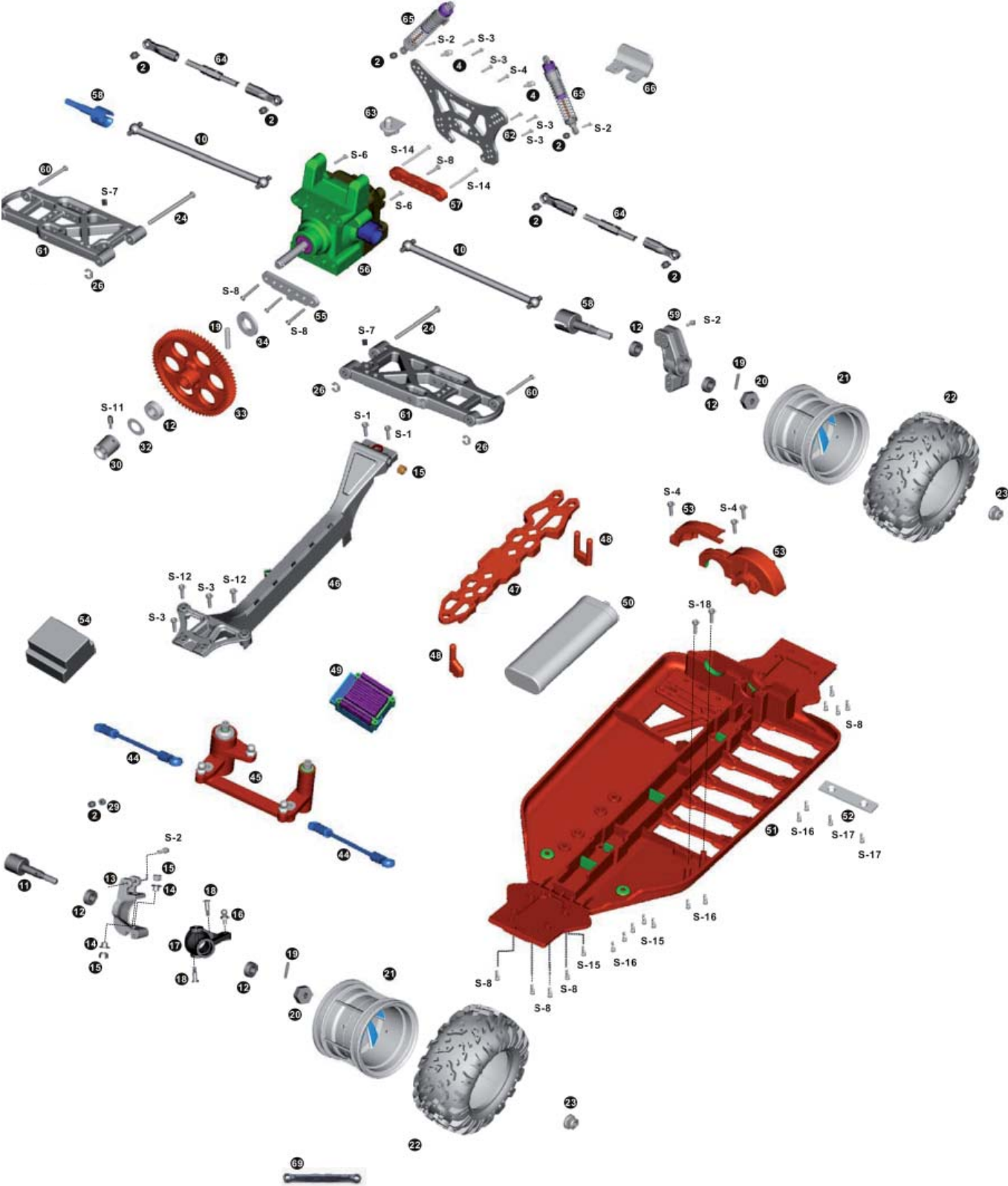



www.himoto-krick.de

Generaldistributor für Himoto Produkte

Krick Modelltechnik

Industriestrasse 1

75438 Knittlingen

Germany

E-Mail: info@krick-modell.de

Fax +49 (0)7043/31838